

elobau ®

sensor technology

made in Germany

Fahrzeug komponenten  
Vehicle components  
Composants pour véhicules



13|14



### Das Unternehmen

**elobau sensor technology –**  
Ihr Partner für berührungslose  
Sensortechnik.

Seit 1972 ist der Erfolg von elobau eng mit Innovation, Zuverlässigkeit und Flexibilität verknüpft. Heute ist das Unternehmen mit über 500 Mitarbeitern einer der führenden Anbieter berührungsloser

Sensortechnik. Neben einem umfangreichen Standardprogramm, bilden vor allem kundenspezifische Lösungen das Angebotsspektrum.

Alle Prozesse in Entwicklung und Fertigung werden bei elobau im eigenen Hause, am Standort Leutkirch im Allgäu, durchgeführt. Den Kern unserer Produkte bilden zwei äußerst zuverlässige und langlebige Technologien: Die Reedkontakte und die Hall-Sensorelemente.

Neben unserem Credo, innovative Produkte mit hoher Fertigungstiefe in Deutschland zu produzieren, fühlen wir uns aus tiefer, innerer Überzeugung sehr der Umwelt und unserer Gesellschaft verpflichtet.



### The Company

**elobau sensor technology –**  
your partner for non-contact  
sensor technology.

Since 1972, elobau's success has been closely linked to innovation, reliability and flexibility. Today the company – which has a work force of more than 500 people – is one of the world's leading manufacturers of non-contact sensor technology. In addition to a broad array of standard products, elobau offers customized solutions.

At elobau we carry out all development and production processes in our own facilities in Leutkirch in Allgäu. Two extremely reliable and long-lived technologies form the core of our products: Reed contacts and Hall sensor elements.

In addition to our credo of producing innovative products in Germany with a high vertical range of manufacture, we are – through deep, internal conviction – committed to our environment and our society.

### L'entreprise

**elobau sensor technology –**  
votre partenaire pour les  
capteurs sans contact.

Depuis 1972, le succès d'elobau est étroitement lié aux concepts d'innovation, de fiabilité et de flexibilité. Aujourd'hui, avec plus de 500 collaborateurs, la société compte parmi les fournisseurs majeurs de techniques sensorielles sans contact. Outre un vaste programme standard, nous proposons surtout des solutions spécifiques aux clients.

Tous les processus de développement et de fabrication sont réalisés sur le site de Leutkirch d'elobau dans l'Allgäu. Deux technologies caractérisées par une grande fiabilité et longévité sont au cœur de nos produits : les contacts Reed et les éléments sensoriels à effet Hall.

Fidèles à notre philosophie qui consiste à fabriquer des produits innovants de degré d'intégration élevé en Allemagne, nous suivons également une conviction intime et profonde en nous engageant à l'égard de l'environnement et de la société.



**elobau goes green.**

#### Wir produzieren klimaneutral.

Erfahren Sie mehr über elobau goes green auf der hinteren Umschlagklappe!

#### We produce in a carbon-neutral manner.

Learn more about "elobau goes green" on the inside of the back cover!

#### Nous produisons avec un bilan carbone neutre.

Vous trouverez plus d'informations concernant l'initiative « elobau goes green » au dos de la couverture.

# 1

Allgemeines  
General data  
Informations générales

3

## 2

Hebel- und Universalschalter  
Lever and universal switches  
Levier de commande et  
commande interrupteur universel

	Hebelschalter Lever switch Levier de commande	17
	Universalschalter Universal switches Commande interrupteur universel	18...20
	Lenkstockschalter Steering column switches Commutateur de colonne de direction	21
	Handgas Hand throttle Accélérateur à main	22

## 3

Joystickbasis und Joystickgriffe  
Joystick base and Joystick handle  
Joystick et poignée

	Kleine Bauform Small version Version miniature	25...30
	Einachsiger Joystick Single axis joystick Joystick un axe	31...33
	Kompakte Bauform Compact design Version compacte	34...37
	Robustjoystick Heavy duty joystick Joystick robuste	38...42
	CAN-Elektronikmodul CAN electronic module Module électronique CAN	43...44
	Multifunktionsgriffe Multi function levers Pommeau multifonctions	45...51
	Daumenrad Thumbwheel Molette proportionnelle	52...55

## 4

Taster  
Push button switches  
Boutons poussoirs

	mit Super-Seal-Stecker / mit Deutsch-Stecker with Super-Seal connector / with Deutsch connector avec connecteur Super-Seal / avec connecteur Deutsch	59...61
	Microtaster Micro push button switches Micro boutons poussoirs	62...66
	Nanotaster Nano push button Bouton poussoirs nano	67...69
	Microtaster analog Analogue micro push button Micro bouton poussoirs analogique	70...71
	Doppeltaste Double push button Bouton poussoir double	72
	Micro-Wipptaste Micro-rocker-switch Micro-bouton à bascule	73
	PTO-Taster mit Super-Seal-Stecker PTO with Super-Seal connector Bouton PTO avec connecteur Super-Seal	74
	PTO-Taster mit Beleuchtung Illuminated PTO Bouton PTO éclairée	75

## 5

Stößelschalter  
Plunger operated switches  
Interrupteurs poussoirs

	Stößelschalter Plunger operated switches Interrupteurs poussoirs	79...82
---	--	---------

# 6

## Winkelsensoren Angle sensors DéTECTEURS ANGULAIREs



Winkelsensoren mit Kugel- oder Gleitlager  
Angle sensor with plain or ball bearing  
DéTECTEUR ANGULAIRE avec palier ou roulement à billes

85...87



Winkelsensor redundant  
Angle sensor with redundancy  
DéTECTEUR ANGULAIRE REDONDANT

88...90



Winkelsensor 360°  
Angle sensor 360°  
DéTECTEUR ANGULAIRE 360°

91...92



CAN-Winkelsensor  
CAN-angle sensor  
DéTECTEUR ANGULAIRE CAN

93...94



Winkelsensor axial  
Axial angle sensor  
DéTECTEUR ANGULAIRE AXIAL

95

# 8

## Füllstandsmessung Level measurement Mesure de niveau



Tankgeber  
Float switch  
Sonde de niveau à flotteur

111...119



Schüttgutschalter  
Bulk material switch  
DéTECTEURS POUR PRODUITS EN VRAC

120...121



Niveauanzeigen  
Level indicators  
Affichages de niveau

122...123

# 9

## Kabelsätze Cable sets Câbles



Kabelsätze  
Cable sets  
Câbles

127...131

# 7

## Neigungssensoren Tilt switches Capteurs de déVERS



Neigungssensoren – einachsig  
Tilt switch – single axis  
Capteurs de déVERS – un axe

99...102



Neigungssensoren – zweiachsig  
Tilt switch – two axis  
Capteurs de déVERS – deux axes

103...106



Winkelanzeige  
Angle instrument  
Affichage angulaire

107

1



Allgemeines  
General data  
Informations générales



2



Hebel- und Universalschalter  
Lever and universal switches  
Levier de commande et commande interrupteur universel

3



Joystickbasis und Joystickgriffe  
Joystick base and Joystick handle  
Joystick et poignée

4



Taster  
Push button switches  
Boutons poussoirs

5



Stößelschalter  
Plunger operated switches  
Interrupteurs poussoirs

6



Winkelsensoren  
Angle sensors  
DéTECTEURS ANGULAIRES

7



Neigungssensoren  
Tilt switches  
Capteurs de dévers

8



Füllstandsmessung  
Level measurement  
Mesure de niveau

9



Kabelsätze  
Cable sets  
Câbles



# 1

## **Allgemeines General data Informations générales**

Fahrzeugkomponenten Vehicle components Composants pour vehicules	5
Kundenspezifische Produkte Customized products Fabrication spécifiques	6
Allgemeines General data Informations générales	7...8
Werkstoffangaben Material information Informations des matériaux	9...10
IP-Schutzklassifikation DIN EN 60529 Protection class DIN EN 60529 Classe de protection DIN EN 60529	11...12
Umrechnungstabellen Conversion tables Tableaux de conversion	13





**Landmaschinen**

Seit über 30 Jahren sind wir im Bereich der Landmaschinen tätig. Angefangen hat die Produktfamilie mit den Stößelschaltern für Getriebe. Heute werden Produkte für den Kabinen-, Außen- und Motorbereich gefertigt. Überwiegend werden die Produkte kundenspezifisch entwickelt und gefertigt. So werden in enger Zusammenarbeit direkt mit dem Kunden, die gewünschten Produkte konstruiert, bemustert und gefertigt. Angefangen von der kleinen Taste bis hin zur kompletten Armrest. elobau ist bei nahezu jedem großen Traktorenhersteller gelistet und verbaut!

**Agricultural equipment**

elobau has been involved in the agricultural equipment industry for over 30 years. The product family started with a tappet plunger switch used in tractor gearboxes. Today, we manufacture products for vehicle cabs, exteriors and engines. Most of the components are developed and produced according to customer specifications. The products are therefore designed, sampled and manufactured in close cooperation with the customer. Offering a complete range, from small push button switches to complete armrests, elobau supplies almost every major agricultural equipment manufacturer!

**Tracteurs**

Depuis plus de 30 ans, elobau est actif dans le secteur des tracteurs. Les premiers produits furent les interrupteurs poussoirs pour boîtes de vitesses. Depuis, nous fabriquons des produits pour la cabine, l'extérieur et le moteur. Les produits sont avant tout développés et fabriqués selon les spécifications du client. Ainsi, les produits souhaités peuvent être construits, échantillonnés et fabriqués en étroite collaboration avec le client. A commencer par les boutons jusqu'à l'accoudoir complet, les produits elobau on les trouve chez quasi tous les grands fabricants de tracteurs!

**Flurförder-Fahrzeuge**

Der Bereich der Material-Umschlagmaschinen ist ein stetig wachsender Markt. Hier beliefern wir die Kunden mit Bedienpanelen, Joysticks und Fußpedalen. Die Maschinensicherheit wird künftig ein noch wichtigeres Thema, auch bei Umschlagmaschinen werden. Hier liefert elobau von der Not-Halt-Taste bis zu Sensoren alle wichtigen Bauteile der Maschinensicherheitsstandards bis PL e gemäß EN ISO 13849-1. Ergonomie und Design sind längst in der Materialwirtschaft angekommen. Hier sind wir Vorreiter insbesondere bei unseren Joystickgriffen und Tastern.

**Material handling**

The material handling machine sector is continually expanding, and elobau supplies customers with control panels, joysticks, and foot pedals among other components. Machine safety is an increasingly important requirement for manufacturers of material handling equipment. elobau can provide several types of components addressing the machine safety standards, including emergency push button switches and sensors, up to PL e according to EN ISO 13849-1. Modern designs with state-of-the-art ergonomics have become important customer demands in material handling equipment, and elobau has been pioneering innovative push-button switches and joystick designs to fulfill them.

**Chariots de manutention**

Le secteur des machines de manutention est un marché en croissance permanente. Ici, elobau livre les panneaux de commande, les manettes et les pédales. La sécurité des machines continue à gagner en importance et ce même aux machines de manutention. Ici elobau livre tous les composants importants, à commencer par les boutons d'arrêt d'urgence aux capteurs jusqu'au PL e selon EN ISO 13849-1. L'ergonomie et le design ont depuis longtemps fait leur entrée dans le monde de la gestion logistique. Ici elobau est le pionnier, en particulier pour les poignées des manettes et les boutons-poussoirs.

**Baumaschinen**

Seit dem Einzug der Elektronik in Baumaschinen liefern wir Bauteile für verschiedenste Anwendungsbereiche wie Bagger, Radlader, Krane und Teleskopstapler. Zur Erfassung von Neigungs- oder Winkelbereichen werden die Sensoren von elobau eingesetzt. Die Steuerung der Fahr- und Arbeitsbewegung übernehmen Taster, Daumenräder und Joysticks. Entnahmeeinheiten und Füllstandsmesser werden zur Versorgung des Fahrzeugs mit Treibstoff und/oder zum Messen von Füllständen beispielsweise bei Hydraulik-Öl eingebaut. Durch die robuste Bauweise der Produkte können diese in rauer Umgebung mit Vibration, Stößen, Feuchtigkeit und Temperaturschwankungen eingesetzt werden.

**Construction vehicles**

elobau started to supply components for various applications in backhoe loaders, excavators, wheel loaders, cranes and telehandlers as soon as electronics became widely used in construction vehicles. elobau sensors are used to provide feedback on inclination and angular ranges. Travelling and working motion of the vehicles are controlled by elobau push button switches, thumbwheels and joysticks. Senders and level switches are used to monitor the level of fuel and hydraulic oil. Thanks to the robust design of the elobau products, Hall effect and Reed switch technologies can be applied in harsh environment, involving vibrations, shocks, moisture and temperature fluctuations.

**Machines de chantiers**

Depuis l'apparition de l'électronique dans les machines de chantiers, elobau fournit les composants pour les applications les plus diverses dans les excavateurs, chargeuses sur roues, grues et télescopes. Pour la saisie des zones inclinées ou angulaires on utilise des capteurs elobau. Et ce sont des boutons-poussoirs, des molettes et des manettes qui se chargent de la commande du mouvement de déplacement et de travail. Les unités de prélèvement et les indicateurs de niveau sont montés pour l'alimentation du véhicule en carburant ou pour mesurer les niveaux d'huile. Grâce à la construction solide des produits, la technologie Hall et Reed peut être utilisée en présence de vibrations, d'humidité et de changements de température.

**Kommunal- und  
Feuerwehrfahrzeuge**

Schnelle und sichere Handhabung lautet hier die Devise. Dieser Bereich hat ein großes Spektrum von Anforderungen, angefangen bei der Entnahme und Messung von Tankinhalten. Große Vielfalt ist auch im Bereich der Bedienteile gegeben. Joysticks oder Taster werden für die verschiedensten Bedienoptionen eingesetzt. Die Maschinensicherheit wird stetig wichtiger. Sicherheitssensoren und Auswerteeinheiten werden von den Kunden immer mehr gewünscht. Für die sichere Bewegungsüberwachung, haben wir unsere Dreh- und Winkel-sensoren im Sortiment.

**Street sweepers, refuse and fire  
fighting vehicles**

Fast and safe handling is the priority in these applications. This industry sector has a wide range of applications for elobau products, starting with the sampling and level measurement of the tank contents. There are also requirements for a wide variety of control components, including joysticks and push button switches for various control applications. Machine safety is becoming increasingly important, therefore machine safety switches and safety control units are now required by many customers. elobau also provides angle sensors to ensure a reliable monitoring of different movements in the vehicles.

**Véhicules utilitaires communaux et  
véhicules de lutte contre l'incendie**

Ici la devise est: maniement rapide et fiable. Ce secteur a un grand éventail d'exigences, à commencer par le prélèvement et le mesurage de contenus de réservoirs. La grande diversité est également garantie dans le domaine des éléments de commande. Les manettes ou les boutons-poussoirs sont utilisés pour les options de commande les plus diverses. La sécurité des machines gagne en importance. Les capteurs de sécurité et les unités d'évaluation sont devenus des incontournables. Pour garantir un contrôle fiable des mouvements, la gamme des produits elobau comprend également des capteurs rotatifs de position et des capteurs angulaires.



Rocla Armrest  
 Rocla Armrest  
 Commande accouoir Rocla



Still Wagner Handgriff  
 Still Wagner handle  
 Poignée Still Wagner



Case verchromter Griff  
 Case chromed handle  
 Poignée chromée Case



AGCO Fendt V/R-Schalter  
 AGCO Fendt V/R switch  
 Commutateur AV/AR AGCO Fendt



Claas Renault Armrest  
 Claas Renault Armrest  
 Commande accouoir Claas Renault

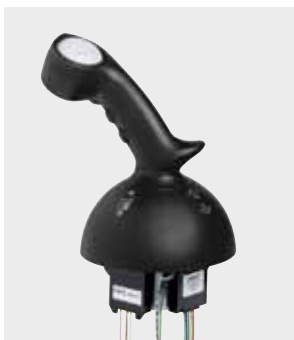

Nissan Handgriff  
 Nissan handle  
 Poignée Nissan

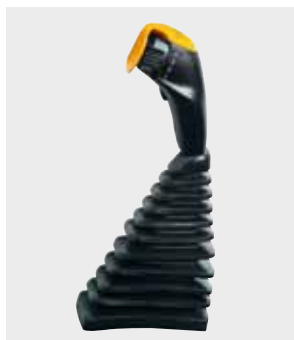

Case Thumbwheel, 4 Positionen  
 Case 4 position thumbwheel  
 Pommeau 4 positions Case

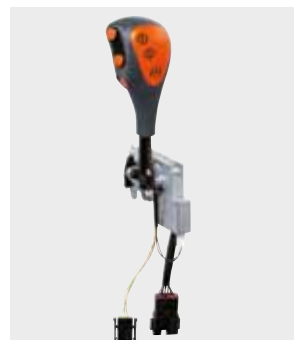

Case FNR  
 Case FNR  
 FNR Case



Steyr Armrest  
 Steyr Armrest  
 Commande accouoir Steyr



AGCO FNA mit Tippfunktion  
 AGCO FNA with Auto Shift function  
 Commande inverseur impulsionele  
 AGCO



Kässbohrer Handgriff  
 Kässbohrer handle  
 Poignée Kässbohrer



Same FNR  
 Same FNR  
 FNR Same

### Schaltleistungsgrenzen

Die gezeigte Strom-Spannungs-Kurve bezieht sich hauptsächlich auf magnetische Näherungsschalter mit eingebauten Reedkontakten.

Achtung: Sowohl Schaltstrom (A) als auch Schaltleistung (VA/W) dürfen in keinem Fall überschritten werden.

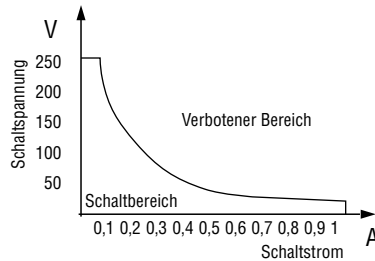

### Switching power limitation

The voltage/current curve, shown below, is mainly applicable to magnetic proximity switches containing reed switches. If in doubt about the type of load, we suggest the use of the paragraph entitled "contact protection"; alternatively, please consult us.

Note: Rated switching current (Amps) as well as rated switching power (VA/W) must never be exceeded under any circumstances.

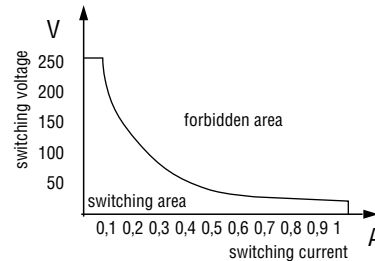

### Valeurs limitées du pouvoir de coupure

La courbe reproduite donnant la tension de commutation en fonction de l'intensité du courant se rapporte typiquement aux interrupteurs de proximité magnétiques à lames souples.

Attention: Il ne faut en aucun cas dépasser ni le courant de commutation ni le pouvoir de coupure (W ou VA).

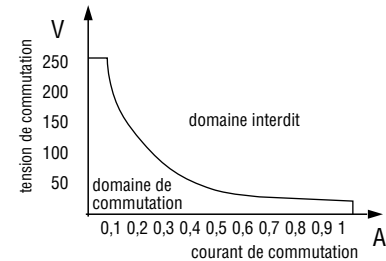

### Elektrische Überlastungsursachen

Glühlampen nehmen beim Einschalten bis zu 20 mal soviel Strom auf, wie es ihrem Nennwert entspricht (der Einschaltstrom einer 5 W-Lampe bei 24 V Schaltspannung kann beispielsweise bis zu 2,5 A betragen).

Kondensatoren – kapazitive Lasten bilden beim Einschalten quasi einen Kurzschluss. In dieses Gebiet gehören auch längere Steuerleitungen, weil die parallel liegenden Drähte wie ein Kondensator wirken. Ab 20 m Leitungslänge können die dadurch auftretenden kapazitiven Belastungen bereits kritisch werden.

Elektromagnetische Spulen (Schütze, Relais, Magnetventile) induzieren beim Abschalten eine sehr hohe Spannung. Sie kann in der Praxis Werte von weit über 1000 V erreichen. Bei Zweifel über die Lastart empfehlen wir den Abschnitt „Kontaktschutzmaßnahmen“ zu Hilfe zu ziehen oder unsere Beratung anzufordern.

### Mechanische Überlastungsursachen

Reedkontakte sind außerordentlich robust gegenüber Schocks. Um sie zu dejustieren, werden mehrere 100 g benötigt. Dieser Wert kommt im Betrieb praktisch nicht vor. Er wird aber ohne weiteres überschritten, wenn die Geräte aus einer bestimmten Höhe auf einen harten Untergrund fallen, oder wenn man sie beispielsweise an der Leitung nimmt und sie „schwungvoll auf die Werkbank legt“. In diesen Zusammenhang gehört auch das „Einjustieren der Kontakte mit dem Hammer“.

Das Gehäuse schützt die Glasampulle der Reedkontakte unter normalen Bedingungen zuverlässig. Allerdings sind Verformungen zu vermeiden, wie sie beispielsweise durch Schläge auf das Gehäuse oder auch durch Anziehen der Befestigungsschraube bis zur Zerreißgrenze entstehen. Bitte beachten Sie auch unser Programm an Schaltern mit integrierem Relais-Ausgang. Neben den Listentypen gibt es Sonderausführungen. Bitte Beratung anfordern.

### Electrical surge loads

Tungsten filament lamps

The current surge on switching from cold can exceed by up to 20 times the nominal rated current, i.e. the switching current of a 5 watt lamp at 24 V could be in excess of 2.5 amps.

Capacitive loads

Can be caused by long cable lengths lying in parallel, which act as a capacitor and can discharge through the switch at very high current levels. Cable length in excess of 20 m could be critical.

Inductive loads

The switching of inductive loads, i.e. contactor and relay coils, solenoid valves, etc., where the back EMF on switch off can exceed the rated breakdown voltage, causing the switch to weld. This voltage can, in practice, exceed values of 1 kV.

### Mechanical surge loads

Reed contacts are extremely insensitive against impact and it takes well in excess of 100 g to knock them out of adjustment. This figure virtually never occurs in normal operation, but can be easily exceeded if the devices fall onto the work bench. This also includes fine "adjustment of the contacts by means of a 4 lb hammer."

The housing is designed to protect the glass switch very well under normal circumstances. However, care must be taken to avoid deforming the housing by such means as hitting it (for position adjustment) or tightening the fixing nuts or screws to the point where the material splits. For heavier loads, switches with integrated relay outputs are available. Data available on request.

### Causes électriques de surcharge

Les lampes à incandescence absorbent à l'enclenchement jusqu'à 20 fois plus de courant que leurs valeurs nominales. Le courant d'enclenchement dans une lampe de 5 W pouvant par exemple, sous une tension 25 V atteindre 2,5 A.

Les condensateurs ou charges capacitives forment pratiquement un court-circuit lors de l'enclenchement. Appartient aussi à cette catégorie les câbles de commande relativement longs étant donné que les fils élec-triques disposés en parallèle se comportent comme un condensateur. A partir d'une longueur de câble de 20 m les charges capacitives qui en découlent peuvent déjà devenir critiques.

Les charges inductives (relais, électrovannes) induisent une tension très élevée aux débranchements. Dans la pratique, cette tension peut très bien atteindre des valeurs nettement supérieures à 1000 V. En cas de doute concernant le type de charge à laquelle ils sont soumis, nous vous recommandons de vous aider du paragraphe «Mesures de protection des contacts» ou de nous consulter.

### Causes de défaillances mécaniques

Les contacts à lames souples sont extrêmement robustes à l'encontre des chocs. Il faut plusieurs centaines de g pour les désajuster. Cette valeur ne se rencontre pratiquement jamais en utilisation normale.

Par contre, elle peut très bien être dépassée lorsque les appareils tombent d'une certaine hauteur sur un sol dur, ou lors d'ajustements au marteau. Dans des conditions normales, le boîtier protège les contacts de façon fiable. Il faut cependant éviter les déformations qui se produisent par exemple à la suite de coups donnés au boîtier ou d'un serrage de la vis de fixation jusqu'à la limite de rupture. Veuillez également noter l'existence de notre gamme d'interrupteurs à sortie à relais intégré. Outre les types décrits dans ce catalogue, il existe également des constructions spéciales. N'hésitez pas à nous consulter.

**Lebensdauer eines Reedkontaktes**

Reedschalter: Die Lebensdauer von Reedkontakten beträgt, abhängig von den Lastbedingungen, zwischen  $10^6$  und  $10^9$  Schaltspielen. Durch das spezielle Kontaktzungenmaterial, das auch nach  $3 \times 10^9$  Schaltspielen keine Brüche aufweist, kann mit Sicherheit eine mechanische Lebensdauer von min.  $3 \times 10^9$  Schaltspielen angenommen werden.

**Anschlusskabel**

Die Standardversion hat PVC-Kabel, 1 m lang,  $0,5-0,75 \text{ mm}^2$  Querschnitt. Bei kleinen Geräten oder kleiner Leistung ist der Leiterquerschnitt  $0,14-0,5 \text{ mm}^2$ .

Temperaturbeständige Schalter sind mit Silikonkabel ausgestattet. Andere Versionen z.B. Teflon, abgeschirmtes Kabel, wärmebeständiges PVC-Kabel auf Anfrage.

Beachten: PVC-Kabel muss bei Temperaturen unter  $-5^\circ\text{C}$  fest verlegt werden.

**Kontaktschutzmaßnahmen**

Bei Reedschaltern dürfen auch kurzzeitig die angegebenen Werte für Schaltstrom und -spannung nicht überschritten werden. Für kapazitive und resistive Lasten (lange Leitungen und Relais/Schütze) empfehlen wir eine Schutzbeschaltung.

Hohe Einschaltstrombelastungen, wie sie beispielsweise bei Kapazitäten oder Glühlampen auftreten, können bis zu einem gewissen Umfang durch Vorwiderstände kompensiert werden. Diese Vorwiderstände begrenzen dann den Maximalwert für den Reedkontakt.

**Kapazitive Belastung**  
**Capacitive load**  
**Crête de charge capacitive**

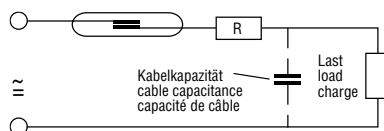

Schutz durch Vorwiderstand  
protected by current limiting resistor  
protégé par résistance série

**Duration of life of a reed switch**

Reed switch: The life of a reed switch is typically  $10^6-10^9$  operations dependent upon load conditions. The special reed blade material is selected to ensure a mechanical life of at least  $3 \times 10^9$  operations.

**Connecting cable**

The standard version has always a PVC cable, 1 metre long, and a cross sectional area of  $0,5-0,75 \text{ mm}^2$ . In the case of small/low power units, then cable having a cross sectional area of  $0,14-0,5 \text{ mm}^2$  is used. Temperature resistant switches are supplied with silicone cable. Other types such as Teflon, screened cable and heat resistant PVC are available on request.

Note: PVC cable must be firmly supported at temperatures below  $-5^\circ\text{C}$ .

**Contact protection**

The specified value of switching current and/or voltage must never be exceeded, even for very short periods. It is strongly recommended that contact protection be used whenever there are capacitive or inductive loads (long leads and relay loads). High inrush loads caused by filament lamp switching or capacitances may be compensated for by using current limiting resistors. These should limit the current to that acceptable to the reed switch.

**Durée de vie d'un contact Reed**

La durée de vie des interrupteurs à lames souples va de  $10^6$  à  $10^9$  opérations en fonction des charges appliquées. Les lames de contact constituées d'un matériau spécial ont une longévité mécanique d'au moins  $3 \times 10^9$  opérations.

**Câble de raccordement**

En standard, nos versions sont munies de câbles PVC de 1 m et de section  $0,5$  à  $0,75 \text{ mm}^2$ . Pour les petits appareils et les puissances faibles, la section du conducteur varie de  $0,14$  à  $0,5 \text{ mm}^2$ .

Les interrupteurs résistants aux hautes températures sont équipés de fils revêtus d'une gaine en silicone. D'autres modèles, par exemple revêtus de téflon, des câbles blindés ou en PVC résistant à la chaleur, sont livrables sur demande.

Veillez noter: en cas de températures inférieures à  $-5^\circ\text{C}$ , tout câble en PVC doit être posé à demeure.

**Mesures de protection des contacts**

Il ne faut pas dépasser, même temporairement, les valeurs indiquées pour le courant de commutation et la tension d'enclenchement appliqués aux interrupteurs à lames souples. Pour contrearrer les crêtes de charges capacitatives ou inductives dues à des longs câbles ou relais, nous recommandons d'effectuer un raccordement de protection.

Une résistance série peut être utilisée pour compenser les effets de condensateurs ou de lampes à incandescence dans le circuit. Cette résistance limite alors la valeur maximale du courant.

**Induktive Belastung**  
**Inductive load**  
**Crête de charge inductive**

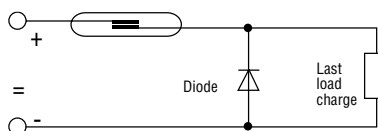

Schutz durch Freilaufdiode  
protection by reverse connected diode  
protection par diode de roue libre

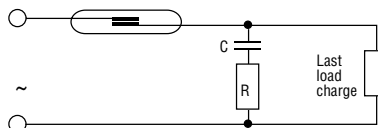

Schutz durch RC-Glied (Bei der richtigen RC-Glied-Bestimmung beraten wir Sie gerne.)  
protected by RC network (To determine the value of the RC network, if required, please call for our advice.)  
protégé par circuit RC (Veuillez nous consulter pour la détermination correcte du circuit RC.)

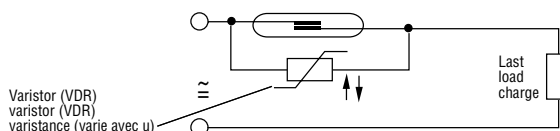

Schutz durch Varistor  
protected by varistor  
protégé par varistance

**Kunststoffe**  
**Plastics**  
**Matières plastiques**

	Systematischer Name chemical name nom systématique	Eigenschaften properties propriétés	Einsatzmöglichkeiten applications domaine d'application	Temperaturbereich temperature range plage de température
ABS	Acrylnitril-Butadien-Styrol	schlagzäh, steif	Säuren, Laugen, Öle	-40...85 °C
	acrylonitrile-butadiene-styrene	impact resistant, rigid	acids, alkalis, oils	
	acrylonitrile-butadiene-styrene	résistant aux chocs, rigide	acides, bases, hydrocarbures	
Hard NBR	Acrylnitril (Nitril-Butadien-Kautschuk)	für Medien mit geringer Dichte	Kraftstoffe, Öle	-25...100 °C
	acrylonitrile	for media with low density	petrol, gas	
	nitrile acrylique	pour des médias avec petite densité	oil, hydrocarbures	
PA	Polyamid	gute mechanische Festigkeit, temperaturbeständig	Laugen, organische Substanzen, PA 12 f. Lebensmittelbereich zugelassen	-40...100 °C
	polyamide	good mechanical strength, temperature stable	alkalis, organic compounds, PA 12 may be used in food processing	
	polyamide	bonne dureté mécanique, stable à la température	bases, composés organiques, PA 12 alimentaire	
PBT	Polybutylenterephthalat	hohe mechan. Festigkeit, temperaturbeständig, chemikalienbeständig, flammhemmende Ausführung möglich	Öle, Fette, Lösungsmittel, Formteile	-25...100 °C
	polybutyleneterephthalate	high mechanical strength, temperature stable, chemical resistant, flame-retarding performance possible	oils, grease, solvents, machines parts	
	polybutyleneterephthalate	dureté mécanique importante, stable à la température, résist. aux agents chimiques, propriétés d. retardateur de feu poss.	hydrocarbures, graisses, dissolvants, pièces de machines	
PC	Polycarbonat	glasklar, zähhart, unzerbrechlich, physiolog. unbedenklich	Öle, Kraftstoffe, Formteile	-40...135 °C
	polycarbonate	transparent, hard, unbreakable, physiologically safe	oils, petrol (gas), machined parts	
	polycarbonate	transparent, dur, incassable, physiologiquement sûr	hydrocarbures, pièces de machines	
PEI	Polyetherimid	hohe mechan. Festigkeit, hohe Temperaturbeständigkeit	Säuren, Laugen, Öle, Formteile	-40...180 °C
	polyetherimide	high mechanical strength, temperature stable	acids, alkalis, oils, machined parts	
	polyetherimide	dureté mécanique importante, stable à la température	acides, bases, hydrocarbures, pièces de machines	
PMMA	Polymethylmethacrylat	klar, transparent, hart, kratzfest, UV-beständig	Laugen, Kraftstoffe, Formteile	-40...85 °C
	polymethylmethacrylate	clear, transparent, hard, resistant to scratches and UV-rays	alkalis, petrol (gas), machined parts	
	polymethylmethacrylate	clair, transparent, dur, résistant aux rayures et aux UV	acides, bases, pièces de machines	
POM	Polyoxymethylen	gute mechan. Festigkeit, hohe Schlagzähigkeit, chemikalienbeständig, physiolog. unbedenklich	Laugen, Formteile	-25...100 °C
	polyoxymethylene	good mechanical strength, high impact strength, chemical resistant, physiologically safe	alkalis, machined parts	
	polyoxymethylene	bonne dureté mécanique, résistant aux impacts importantes, résistant aux agents chimiques, physiologiquement sûr	bases, pièces de machines	
PP	Polypropylen	schlagzäh, geringes spez. Gewicht, hohe Formbeständigkeit, chemikalienbeständig, physiolog. unbedenklich	Laugen, Formteile	-15...100 °C
	polypropylene	impact resistant, low density, dimensionally stable, chemical resistant, physiologically safe	alkalis, machined parts	
	polypropylene	résistant aux chocs, faible densité, non déformable, résistant aux agents chimiques, physiologiquement sûr	bases, pièces de machines	
PPS	Polyphenylensulfid	temperaturbeständig, formbeständig, sehr gute Chemikalienbeständigkeit, flammhemmende Ausführung möglich	Säuren, Laugen, Öle, Kraftstoffe, Formteile	-40...160 °C
	polyphenylenesulfide	temperature stable, dimensionally stable, chemical resistant, flame-retarding performance possible	acids, alkalis, oils, petrol (gas), alcohol, machined parts	
	polyphenylenesulfide	stable à la température, résistant aux agents chimiques, non déformable, propriétés de retardateur de feu possible	acides, bases, hydrocarbures, alcools, pièces de machines	

**Kunststoffe**  
**Plastics**  
**Matières plastiques**

	Systematischer Name chemical name nom systématique	Eigenschaften propriétés propriétés	Einsatzmöglichkeiten applications domaine d'application	Temperaturbereich temperature range plage de température
PVC	Polyvinylchlorid	gute mechan. Festigkeit, physiolog. unbedenklich (lieferbar), witterungsbeständig	Säuren, Laugen, Öle, Formteile	-10...65 °C
	polyvinylchloride	good mechanical strength, physiologically safe (available), weathering resistant	acids, alkalis, oils, machined parts	
	chlorure de polyvinyle	bonne résistance mécanique, physiologiquement neutre (livrable)	acides, lavage alcalin, huiles, éléments de formage	
PTFE	Teflon	beste Temperatur- und Chemikalienbeständigkeit, geringe Formstabilität, selbstschmierend, physiolog. unbedenklich	Säuren, Laugen, Öle, Kraftstoffe, Formteile	-200...260 °C
	teflon	temperature stable, chemical resistant, not dimensionally stable, self-lubricating, physiologically safe	acids, alkalis, oils, petrol (gas), machined parts	
	teflon	stable à la température, résistant aux agents chimiques, déformable, autolubrifiant, physiologiquement sûr	acides, bases, hydrocarbures, pièces de machines	
PVDF	Polyvinylidenfluorid	hohe mechan. Festigkeit, temperaturbeständig, chemikalienbeständig, physiolog. unbedenklich	Säuren, Laugen, Öle, Kraftstoffe, Formteile	-25...100 °C
	polyvinylidene fluoride	high mechanical strength, temperature stable, chemical resistant, physiologically safe	acids, alkalis, oils, petrol (gas), machined parts	
	polyvinylidene fluoride	dureté mécanique importante, stable à la température, résistant aux agents chimiques, physiologiquement sûr	acides, bases, hydrocarbures, pièces de machines	

**Metalle**  
**Metals**  
**Métaux**

	Material material matériau	Eigenschaften propriétés propriétés	Einsatzmöglichkeiten applications domaine d'application	Temperaturbereich temperature range plage de température
Al	Aluminium (veredelt)	hohe mechan. Festigkeit, leicht	Maschinen- und Werkzeugbau	-40...100 °C
	aluminium (finished)	high mechanical strength, light weight	construction of machines and vehicles	
	aluminium (affiné)	dureté mécanique importante, faible densité	construction de machines et véhicules	
GD-Zn	Zink-Druckguss	gute Festigkeit, gute Beständigkeit		-60...220 °C
	zinc diecasting	good strength, good stability		
	zamak	bonne dureté, bonne stabilité		
Ms(CuZn)	Messing	hohe mechan. Festigkeit, antimagnetisch, rostfrei	universell, Maschinen- u. Werkzeugbau	-40...100 °C
	brass	high mechanical strength, non-magnetic, rust-free	construction of machines and vehicles	
	laiton	dureté mécanique importante, non-magnétique, inoxydable	construction de machines et véhicules	
VA	Edelstahl	hohe mechan. Festigkeit, antimagnetisch, rostfrei	chem. u. pharmazeutische Industrie, Nahrungs- u. Genussmittelindustrie	-40...160 °C
	stainless steel	high mechanical strength, non-magnetic, rust-free	chemical and pharmaceutical industry, food and luxury food industry	
	aciers inoxydables	dureté mécanique importante, non-magnétique, inoxydable	industrie chimique et pharmaceutique, industrie alimentaire	
9 SMn Pb 28	Automatenstahl (veredelt)	hohe mechan. Festigkeit	Maschinen- u. Fahrzeugbau	-40...100 °C
	free cutting steel (finished)	high mechanical strength	construction of machines and vehicles	
	aciers de décolletage	dureté mécanique importante	construction de machines et véhicules	

In den neuesten Standards (SFS-EN 60 529: 1992) für die Gehäuseschutzarten von elektrischen Geräten wird insbesondere das Test- und Markierungsverfahren für den Wasserschutz detailliert ausgeführt.

Bis zur Klasse 6 ist festgelegt, dass automatisch auch die Spezifikationen der unteren Klassen erfüllt werden. In höher liegenden Schutzklassen muss jede Klasse separat getestet und auch in entsprechender Weise markiert werden (z. B. IP 67 / IP 66).

The latest standards (SFS-EN 60 529) for classifying the degrees of protection of electrical equipment describe especially in detail the test and marking procedure for the protection against water.





It is committed up to class 6, that the specifications of the lower classes are fulfilled as well. With higher classes, each class must be tested separately and marked correspondingly (e. g. IP 67 / IP 66).

La dernière norme (SFS-EN 60 529) classifiant les degrés de protection des équipements électriques détaille la procédure de test et de marquage de la protection contre l'eau.

Il est convenu que jusqu'à la classe de protection 6, les spécifications des classes inférieures sont également remplies. Pour des classes de protection supérieures, celles-ci doivent être testées séparément et dotées d'un marquage correspondant (par exemple IP67 / IP66).

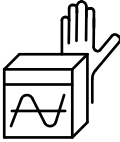

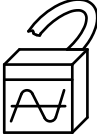

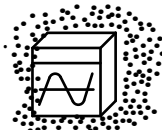
**Erste Ziffer**  
**First number**  
**Premier chiffre**

**Schutzgrad für Berührungs- und Fremdkörperschutz**  
**Protection against solid objects**  
**Protection contre les corps solides**

Erste Ziffer First number Premier chiffre	Schutzgrad für Berührungs- und Fremdkörperschutz Protection against solid objects Protection contre les corps solides			
IP 0		nicht geschützt	non-protected	non protégé
1		geschützt gegen Eindringen von festen Fremdkörpern $\geq 50$ mm Durchmesser (z. B. Handrücken)	protected against solid objects of 50 mm diameter and greater	protégé contre les corps solides étrangers de diamètre 50 mm et plus grands
2		geschützt gegen Eindringen von festen Fremdkörpern $\geq 12,5$ mm Durchmesser (z. B. Finger)	protected against solid objects of 12,5 mm diameter and greater	protégé contre les corps solides étrangers de diamètre 12,5 mm et plus grands
3		geschützt gegen Eindringen von festen Fremdkörpern $\geq 2,5$ mm Durchmesser (z. B. Werkzeug)	protected against solid objects of 2,5 mm diameter and greater	protégé contre les corps solides étrangers de diamètre 2,5 mm et plus grands
4		geschützt gegen Eindringen von festen Fremdkörpern $\geq 1,0$ mm Durchmesser (z. B. Draht)	protected against solid objects of 1,0 mm diameter and greater	protégé contre les corps solides étrangers de diamètre 1,0 mm et plus grands
5		staubgeschützt	dust-protected	protégé contre la poussière
6		staubdicht	dust-tight	étanche à la poussière

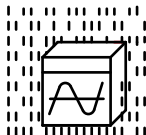
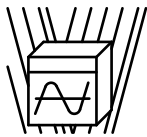
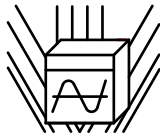
Zweite Ziffer  
Second number  
Deuxième chiffre

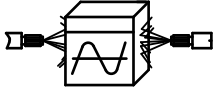
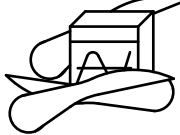
Schutzgrad für Wasserschutz  
Protection against water  
Protection contre la pénétration de l'eau

Zweite Ziffer Second number Deuxième chiffre	Schutzgrad für Wasserschutz Protection against water Protection contre la pénétration de l'eau			
IP 0		nicht geschützt	non-protected	non protégé
1		geschützt gegen Tropfwasser	protected against vertically falling water drops	protégé contre les chutes verticales de gouttes d'eau
2		geschützt gegen Tropfwasser, wenn das Gehäuse bis zu 15° geneigt ist	protected against vertically falling water drops when enclosure tilted up to 15°	protégé contre les chutes verticales de gouttes d'eau avec une enveloppe inclinée au maximum de 15°
3		geschützt gegen Sprühwasser	protected against spraying water	protégé contre l'eau en pluie
4		geschützt gegen Spritzwasser	protected against splashing water	protégé contre les projections d'eau
5		geschützt gegen Strahlwasser	protected against water jets	protégé contre les jets d'eau
6		geschützt gegen starkes Strahlwasser	protected against powerful water jets	protégé contre les jets d'eau puissants
7		geschützt gegen die Wirkungen beim zeitweiligen Untertauchen in Wasser	protected against the effects of temporary immersion in water	protégé contre les effets d'une immersion temporaire dans l'eau
8		geschützt gegen die Wirkungen beim dauernden Untertauchen in Wasser	protected against the effects of continuous immersion in water	protégé contre les effets d'une immersion prolongée dans l'eau
9K		Wasser, das aus jeder Richtung unter stark erhöhtem Druck gegen das Gehäuse gerichtet ist, darf keine schädliche Wirkung haben	water, that is sprayed against the housing from every direction at very high pressure must not cause damage	Non endommagé par les effets de l'eau projetée à haute pression provenant de toutes directions



**Umrechnungstabelle – Länge**  
**Conversion table – length**  
**Tableau de conversion – longueur**

cm	→	inches	× 0.3937
mm	→	inches	× 0.03937
cm	→	feet	× 0.03281
m	→	feet	× 3.281
m	→	inches	× 39.37
inches	→	mm	× 25.4
feet	→	cm	× 30.48

**Umrechnungstabelle – Temperatur**  
**Conversion table – temperature**  
**Tableau de conversion – température**

°C	→	°F	$\times (\text{°C} \times 9/5) + 32$
°F	→	°C	$\times (\text{°F} - 32) \times 5/9$
°C	→	°K	$\text{°C} + 273.18$

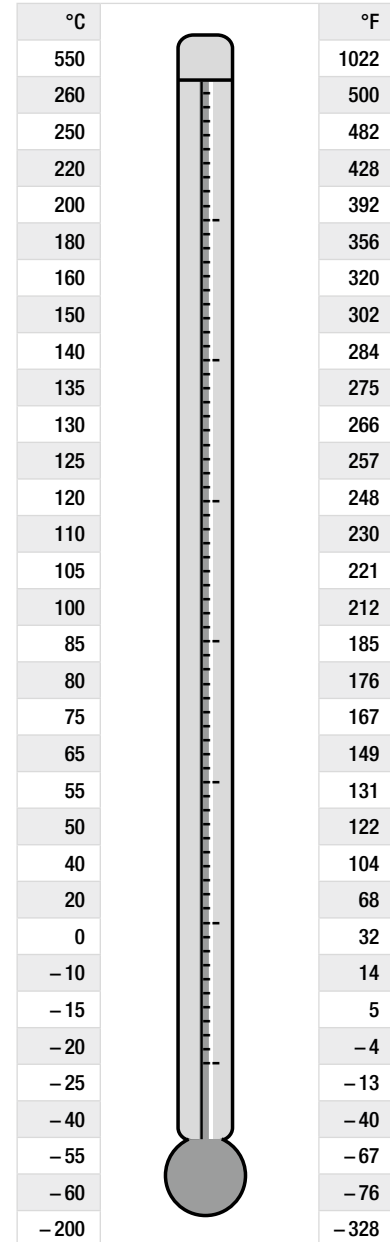



# 2

## Hebel- und Universalschalter Lever and universal switches Levier de commande et commande interrupteur universel



Hebelschalter  
Lever switch  
Levier de commande

17



Universalschalter  
Universal switches  
Commande interrupteur universel

18...20



Lenkstockscharter  
Steering column switches  
Commutateur de colonne de direction

21



Handgas  
Hand throttle  
Accélérateur à main

22





# Universalschalter Universal switches Commande interrupteur universel

## 151 U...A

mit zwei Schaltebenen  
with two switching levels  
avec deux niveaux de commutation

U<sub>B</sub>  
48 V

IP 54

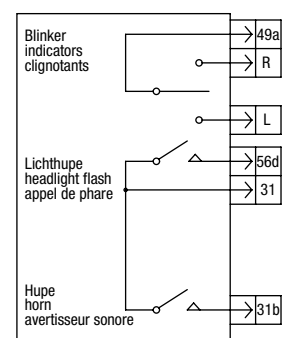
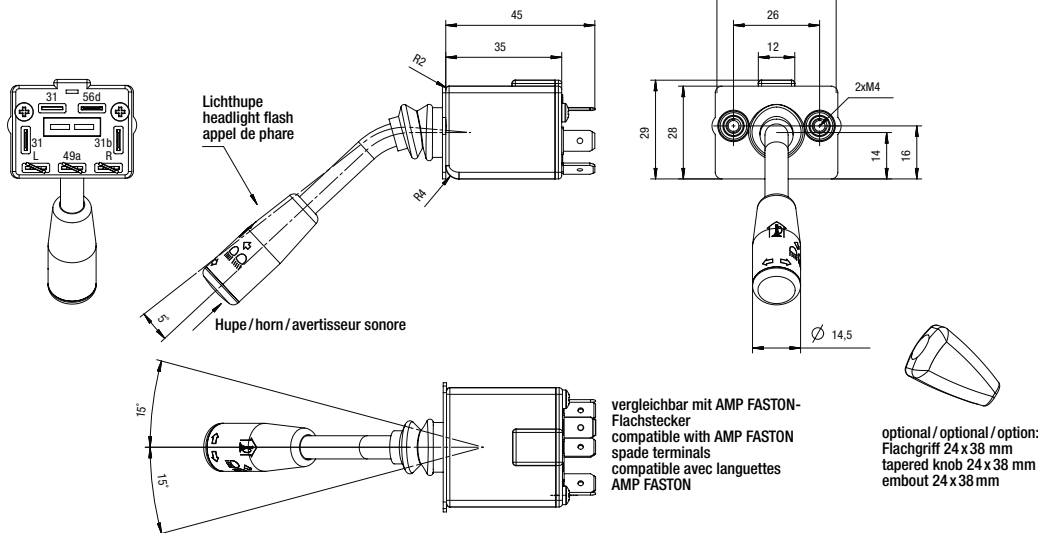

## 151U . S . . . A

**Griffaufdruck**  
1 = Blinker, Hupe, Licht  
2 = ohne Aufdruck  
9 = Kundenwunsch

**Griff**  
0 = großer Griff (ø 17 mm)  
1 = kleiner Griff (Standard ø 14,5 mm)  
2 = Flachgriff  
9 = Kundenwunsch

**Hebelausführung**  
S = Standardhebel

**Funktionsart**  
N = Tastbetrieb\*

M = Rastbetrieb (3 Pos.)  
A = 2 rastende Endstellungen (keine Mittelstellung)  
B = Tastbetrieb\*, verriegelt in Neutralstellung, ohne Lichthupe, mit Verriegelungsüberwachungskontakt  
C = Rastbetrieb, verriegelt in Neutralstellung (auf Anfrage), ohne Lichthupe, mit Verriegelungsüberwachungskontakt

**handle marking**  
1 = indicators, horn, lights  
2 = without marking  
9 = customer specified

**handle**  
0 = large handle (ø 17 mm)  
1 = small handle (standard ø 14,5 mm)  
2 = tapered handle  
9 = customer specified

**lever style**  
S = standard lever

**functions**  
N = momentary\*, spring biased to centre  
M = mechanical contacts, 3 positions, centre off  
A = 2 x end positions (no neutral)  
B = momentary\*, neutral position lock (on request), with monitoring contact, no headlight flash  
C = mechanical contacts, 3 positions, neutral position lock (on request), with monitoring contact, no head-light flash

**marquage de l'embout**  
1 = clignotants, avertisseur sonore, feux  
2 = sans marquage  
9 = spécifications client

**embout**  
0 = embout (ø 17 mm)  
1 = embout petit (standard ø 14,5 mm)  
2 = embout 24x38 mm  
9 = spécifications client

**type de levier**  
S = levier standard

**fonctions**  
N = rappel du levier au centre, positions droite-gauche momentanées\*  
M = 3 positions stables: droite-milieu-gauche  
A = 2 positions stables: droite-gauche (pas de position milieu)  
B = rappel du levier au centre, positions droite-gauche momentanées\*, sans appel de phares, position milieu verrouillage sur demande  
C = 3 positions stables: droite-milieu-gauche, sans appel de phares, position milieu verrouillage sur demande

	Kontakte contacts contacts	max. Schaltspannung max. switching voltage tension de commutation max.	max. Schaltstrom max. switching current courant de commutation max.	max. Schaltleistung max. switching power pouvoir de coupure max.	Schutzart protection class protection	Temperaturbereich temperature range plage de température
Blinker indicators clignotants	L/49a/R	48 V <sup>1)</sup> 12 V <sup>2)</sup>	0,5 A <sup>1)</sup> 8 A <sup>2)</sup>	10 W <sup>1)</sup> 96 W <sup>2)</sup>	IP 54	-30...+80°C
Hupe horn avertisseur sonore	31/31b	12 V	4,16 A	50 W induktiv inductive inductif		
Lichthupe headlight flash appel de phare	31/56d	12 V	0,256 A	3 W induktiv inductive inductif		

1) Tastbetrieb, momentary positions momentanées 2) Rastbetrieb, mechanical contacts, positions stables  
\* Bei Tastbetrieb Ausführung der Blinkfunktion in Reedtechnik. The momentary version utilises reed switch contacts for the indicators. Les contacts des positions momentanées (clignotants) sont des interrupteurs reed.

# Universalschalter Universal switches Commande interrupteur universel

## 151 U...B

mit drei Schalteebenen  
with three switching levels  
avec trois niveaux de commutation

$U_B$   
48 V

IP 54

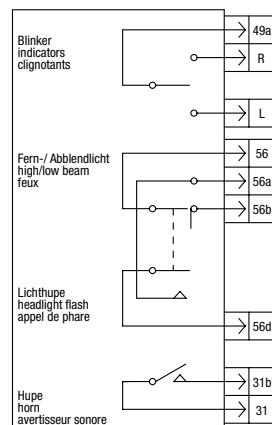
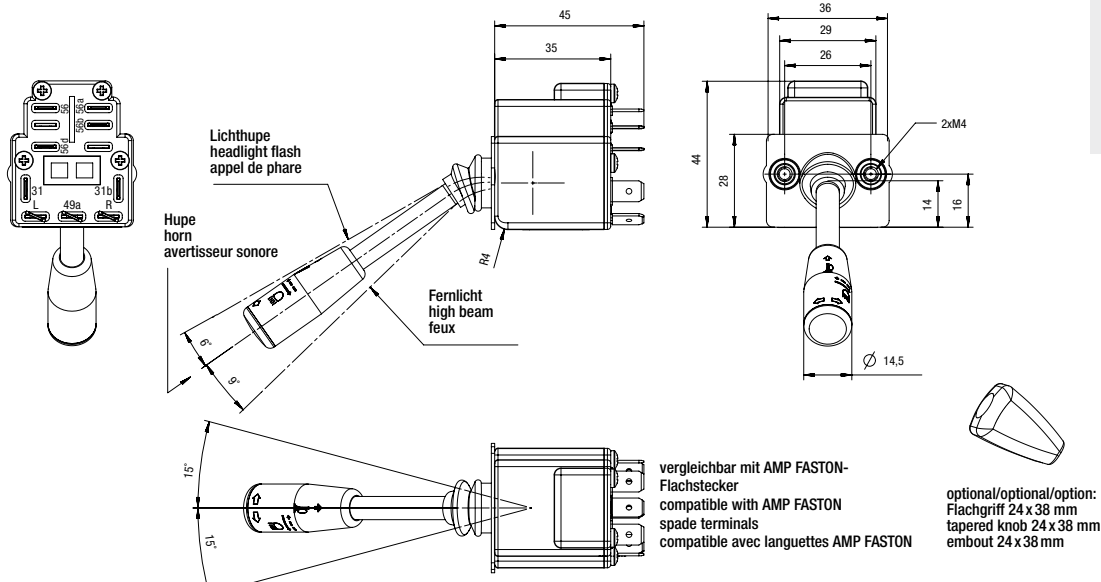

## 151U . S . . B

**Griffaufdruck**  
0 = Blinker, Hupe, Licht, Lichthupe  
2 = ohne Aufdruck  
9 = Kundenwunsch

**Griff**  
0 = großer Griff (ø 17 mm)  
1 = kleiner Griff (Standard ø 14,5 mm)  
2 = Flachgriff  
9 = Kundenwunsch

**Hebelausführung**  
S = Standardhebel

**Funktionsart**  
N = Tastbetrieb\*

M = Rastbetrieb (3 Pos.)  
A = 2 rastende Endstellungen auf Anfrage (keine Mittelstellung)

**handle marking**  
0 = indicators, horn, lights, headlight flash  
2 = without marking  
9 = customer specified

**handle**  
0 = large handle (ø 17 mm)  
1 = small handle (standard ø 14,5 mm)  
2 = tapered handle  
9 = customer specified

**lever style**  
S = standard lever

**functions**  
N = momentary, spring biased to centre\*

M = mechanical contacts, 3 positions, centre off  
A = 2 x end positions on request (no neutral)

**marquage de l'embout**  
0 = clignotants, avertisseur sonore, feux  
2 = sans marquage  
9 = spécifications client

**embout**  
0 = embout (ø 17 mm)  
1 = embout petit (standard ø 14,5 mm)  
2 = embout 24 x 38 mm  
9 = spécifications client

**type de levier**  
S = levier standard

**fonctions**  
N = rappel du levier au centre, positions droite-gauche momentanées\*  
M = 3 positions stables: droite-milieu-gauche  
A = 2 positions stables: droite-gauche sur demande (pas de position milieu)

	Kontakte contacts contacts	max. Schaltspannung max. switching voltage tension de commutation max.	max. Schaltstrom max. switching current courant de commutation max.	max. Schaltleistung max. switching power pouvoir de coupure max.	Schutzart protection class protection	Temperaturbereich temperature range plage de température
Blinker indicators clignotants	L/49a/R	48 V <sup>1)</sup> 12 V <sup>2)</sup>	0,5 A <sup>1)</sup> 8 A <sup>2)</sup>	10 W <sup>1)</sup> 96 W <sup>2)</sup>	IP 54	-30...+80°C
Hupe horn avertisseur sonore	31/31b	12 V	4,16 A	50 W induktiv inductive inductif		
Lichthupe headlight flash appel de phare	56a/56d	12 V	10 A	120 W		
Fern-/Abblendlicht high/low beam feux de route/ croisement	56/ 56a/ 56b	12 V	10 A	120 W		

1) Tastbetrieb, momentary, positions momentanées 2) Rastbetrieb, mechanical contacts, positions stables

\* Bei Tastbetrieb Ausführung der Blinkfunktion in Reedtechnik. The momentary version utilises reed switch contacts for the indicators. Les contacts des positions momentanées (clignotants) sont des interrupteurs reed.

# Universalschalter Shuttle Lever Universal switches Shuttle Lever Commande interrupteur universel Shuttle Lever

## 151SL.....

mit Flachgriff / with tapered handle / avec poignée plate

U<sub>B</sub>  
48 V

IP 67

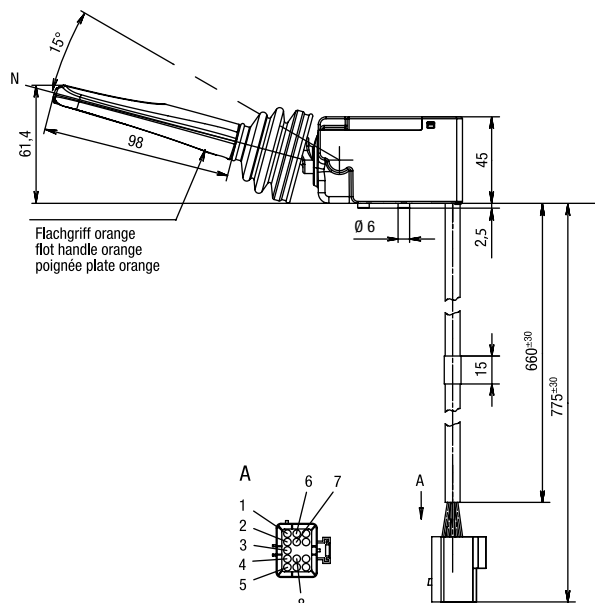
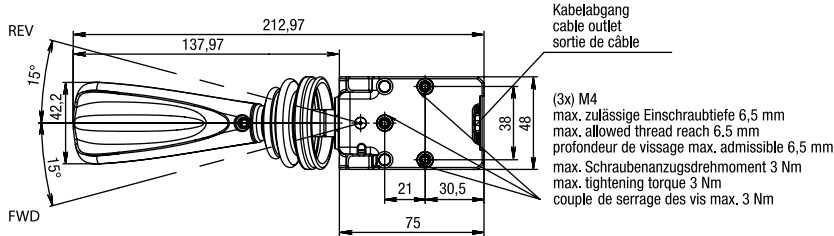

Griffaufdruck nach Kundenangabe  
handle print in accordance  
with customer specifications  
marquage sur la poignée selon spécification client

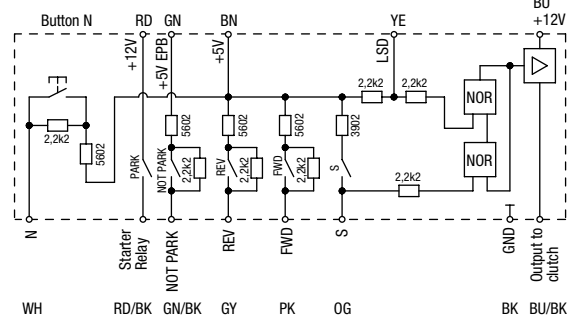
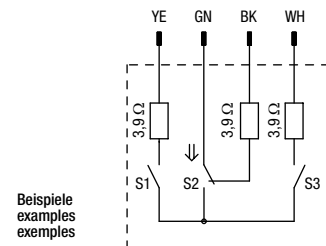
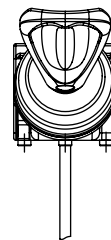

### Optional mit Rundgriff / Optionally with round handle / Avec poignée ronde en option

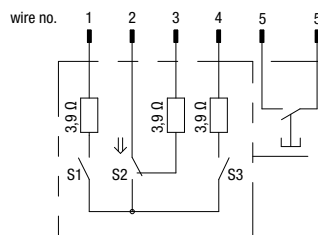
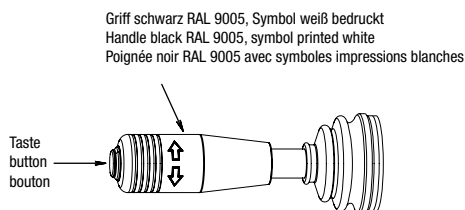

Typen Nr. type no. référence	max. Schaltspannung max. switching voltage tension de commutation max.	max. Schaltstrom max. switching current courant de commutation max.	max. Schaltleistung max. switching power pouvoir de coupure max.	Temperaturbereich temperature range plage de température	Schutzart protection class indice de protection
151SL.. Reedtechnik reed technique technique Reed	48 V	0,5 A	10 W	Lagertemperatur: -40°...+85° Arbeitstemperatur: -30°...+85° storage temperature: -40°...+85° operating temperature: -30°...+85°	IP 67 DIN EN 60529
151SL.. elektronisch* electronic électroniques	9-32 V DC	5 A DC	-	plage de température de stockage: -40°...+85° plage de température d'utilisation: -30°...+85°	

\* max. Anzahl elektronischer Leistungsausgänge sind schaltungsabhängig (auf Anfrage)  
max. number of electronic power outputs are dependent on the circuit (on request)  
le nombre max. des sorties de puissance électronique dépend du circuit électrique souhaité (sur demande)



# Lenkstockscharter

## Steering column switches

### Commutateur de colonne de direction

#### 151 LSS ...

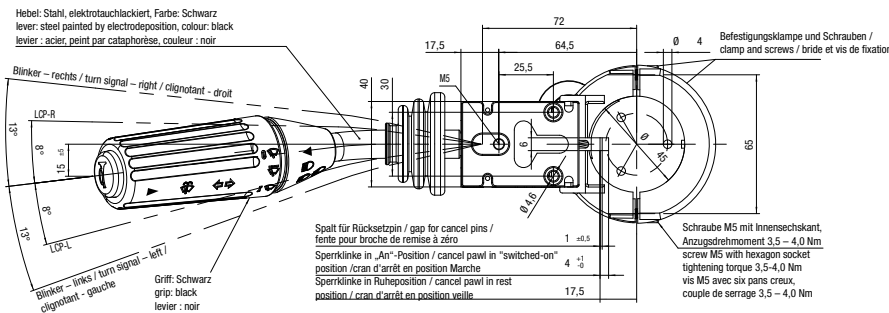
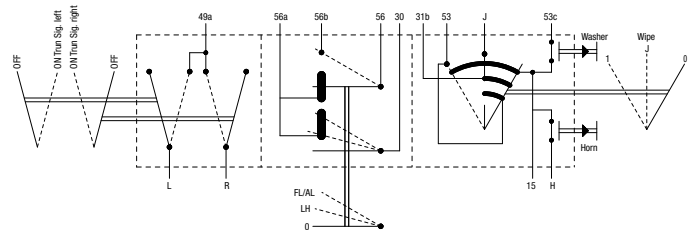
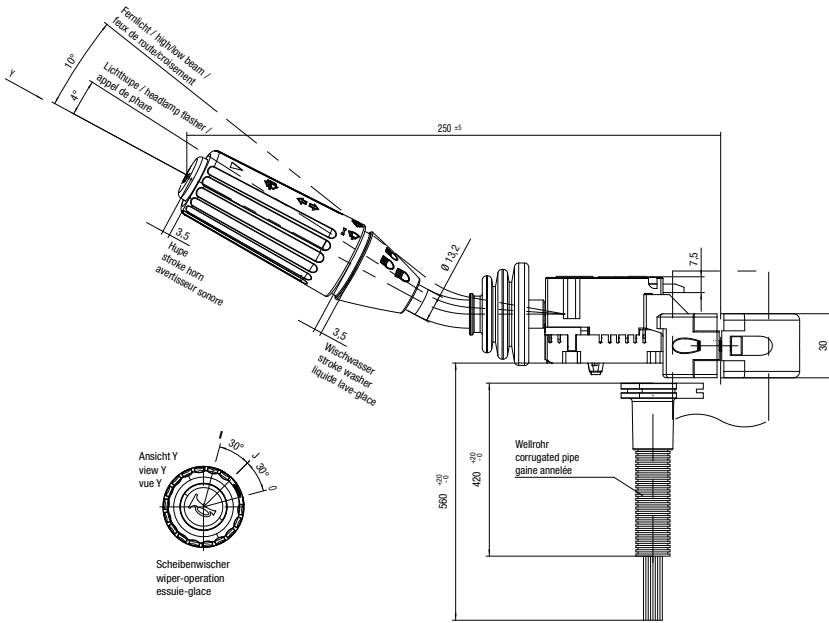

	Kontakte contacts	max. Schaltspannung max. switching voltage tension de commut. max.	max. Schaltstrom max. switching current courant de commutat. max.	max. Schaltleistung max. switching power pouvoir de coupure max.	Schutzart protection class protection	Temperaturbereich temperature range plage de température
Blinker / indicators / clignotants	49a-L 49a-R	12 V	10,5 A	6 × 21 W	Schalt- elemente switching elements: dispositif de commutation: IP6K7 DIN 40050 Part 9  Gehäuse: housing: boîtier: IP55 IEC 60529	-30...+70°C
Hupe / horn / avertisseur sonore	15-H	12 V	5,5 A	---		
Lichthupe headlight flash appel de phare	30-56a	12 V	10,8 A	2 × 65 W		
Fern-/Abblendlicht high/low beam feux de route/croisement	56-56a 56-56b	12 V	10,8 A 9,1 A	2 × 65 W 2 × 55 W		
Dauerwischer Continuous wiper operation Essuie-glace balayage continu	15-53	12 V	8 A	ca. 96 W		
Intervallwischer Interval wiper operation Essuie-glace balayage intermittent	15-J	12 V	8 A	ca. 96 W		
Wischwasser stroke washer liquide lave-glace	15-53c	12 V	5 A	ca. 60 W		

Änderungen und Irrtümer bleiben vorbehalten. Abbildungen ähnlich. Maßgeblich sind die dem ausgelieferten Produkt beigelegten technischen Dokumentationen. The relevant corresponding technical documents will be supplied with the product. Certain product descriptions can be similar therefore please ensure that you have the latest version of documentation for your specific product prior to any use. elobau reserves the right to change technical data and documentation without notice. Sous réserve de modifications et d'erreurs. Images similaires. Les documentations techniques accompagnant les produits sont d'application.

# Handgas Hand throttle Accélérateur à main

351H008

U<sub>B</sub>  
5 V

IP 67

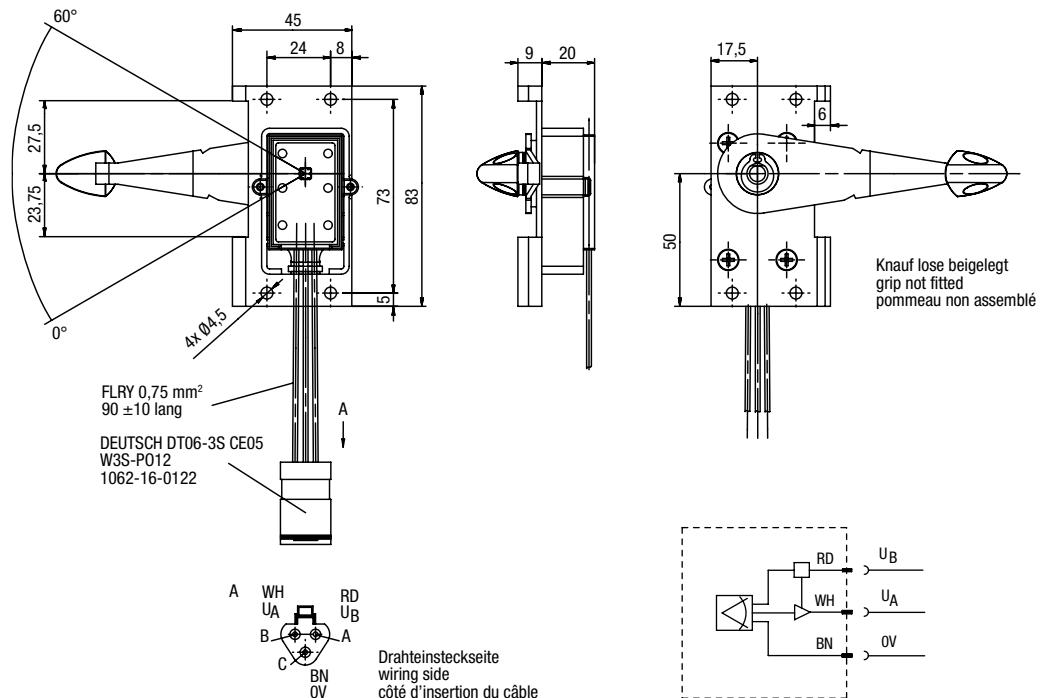
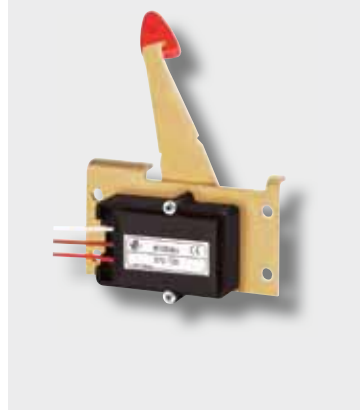

Weitere Elektronikausführungen (Strom- und Spannungsausgang) und Montagebleche optional verfügbar.  
Other electronic specifications (current- and voltage outputs) and mounting plates are available.  
Autres types d'électroniques (sorties courant ou tension) et autres supports de fixation disponibles.

Typen Nr. type no. référence	Betriebsspannung operating voltage tension d'alimentation	max. Betriebsstrom max. operating current courant d'alimentation max.	Ausgangsspannung output voltage tension de sortie
351H008	4,5–5,5 VDC	15 mA	0,5 (0°) – 4,5 (60°) VDC ratiom./prop.
Typen Nr. type no. référence	Lastwiderstand load resistance résistance de charge	Temperaturbereich temperature range plage de température	Schutzart protection class indice de protection
351H008	> 20 kΩ	-25...+75°C	IP 67 DIN EN 60529

# 3

## Joystickbasis und Joystickgriffe Joystick base and Joystick handle Joystick et poignée



Kleine Bauform  
Small version  
Version miniature

25...30



Einachsiger Joystick  
Single axis joystick  
Joystick un axe

31...33



Kompakte Bauform  
Compact design  
Version compacte

34...37



Robustjoystick  
Heavy duty joystick  
Joystick robuste

38...42



CAN-Elektronikmodul  
CAN electronic module  
Module électronique CAN

43...44



Multifunktionsgriffe  
Multi function levers  
Pommeau multifonctions

45...51



Daumenrad  
Thumbwheel  
Molette proportionnelle

52...55





# Joystickbasis und Joystickgriffe

## Joystick base and Joystick handle

### Joystick et poignée

J1 .....

**Joystickbasis – kleine Bauform**  
**Joystick base – small version**  
**Joystick – version miniature**

SIL-  
capable  
EN61508

U<sub>B</sub>  
5 V

V<sub>out</sub>  
I<sub>out</sub>

IP 67

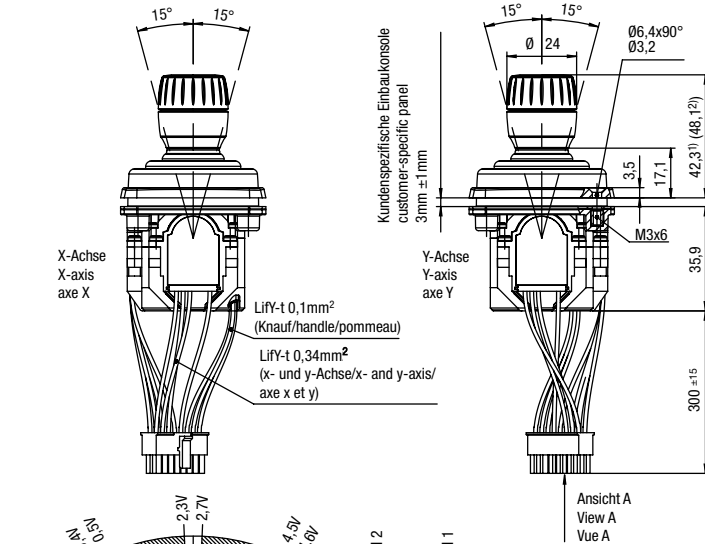

Aufbauhöhe je nach Montageart  
 Height depends on mounting location  
 Hauteur dépendant du montage

x-Achse  
x-axis  
axes x

y-Achse  
y-axis  
axes y

Micro Fit 3.0 housing 43025-1600

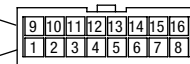

Ansicht A  
View A  
Vue A

**Steckerbelegung der Joystickbasis**  
**connector assignment of the joystick base**  
**(X- und Y-Achse)**  
**affection du connecteur pour la base joystick (axes X et Y)**

**J1R6.....**

1	UB1	9	UB1
2	SIG1	10	SIG1
3	GND1	11	GND1
4	UB2	12	UB2
5	SIG2	13	SIG2
6	GND2	14	GND2
7	15	15	SIG1
8	16	16	SIG2

**Steckerbelegung des Joystickknaufs**  
**connector assignment of the joystick handle**  
**(X- und Y-Achse)**  
**affection du connecteur pour la poignée**

**J1...ZH..**

1	9
2	10
3	11
4	12
5	13
6	14
7	UB
8	GND
	15 SIG1
	16 SIG2

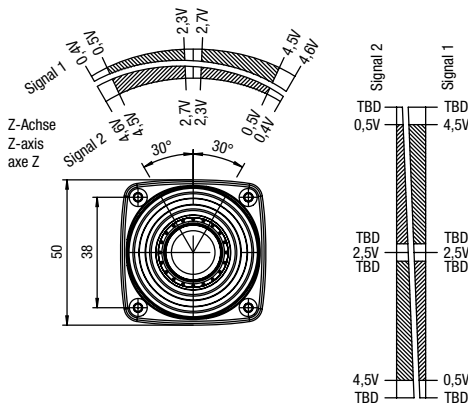

- Einbau von unten  
1) bottom mount  
1) montage par le dessous
- Einbau von oben  
2) top mount  
2) montage par le dessus

**J1H6.....**

1	UB	9	UB
2	SIG1	10	SIG1
3	GND	11	GND
4	12	12	UB2
5	SIG2	13	SIG2
6	14	14	GND2
7	15	15	SIG1
8	16	16	SIG2

**J1...ZA..**

1	9
2	10
3	11
4	12
5	13
6	14
7	UB
8	GND 1
	15 SIG1
	16 SIG2

**J1A6.....**

1	UB	9	UB
2	SIG1	10	SIG1
3	GND	11	GND
4	12	12	UB2
5	13	13	SIG2
6	14	14	GND2
7	15	15	SIG1
8	16	16	SIG2

**J1...TS..**  
**J1...TN..**

1	9
2	10
3	11
4	12
5	13
6	14
7	SIG1
8	15 SIG1
	16

■ = empfohlener Toleranzbereich  
 = recommended tolerance range  
 = Plage de tolérance recommandée

**Analog Z-Achse**  
**analogue Z-axis**  
**analogique axes Z**

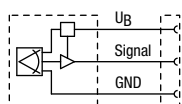

**Analog jeweils X- und Y-Achse**  
**analogue each X- and Y-axis**  
**analogique axes X et Y**

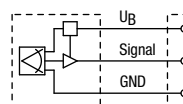

**Halbredundant Z-Achse**  
**semi-redundant Z-axis**  
**semi-redondant axes Z**

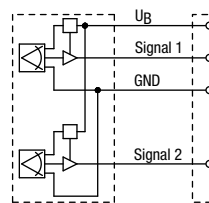

**Halbredundant jeweils X- und Y-Achse**  
**semi-redundant each X- and Y-axis**  
**semi-redondant axes X et Y**

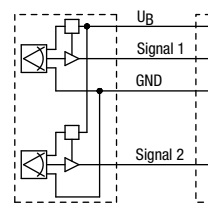

**Redundant jeweils X- und Y-Achse**  
**redundant each X- and Y-axis**  
**redondant axes X et Y**

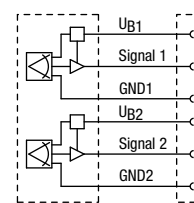

Der Winkelmessbereich beträgt ±15°. Das Messprinzip ist kontaktlos. Beim analogen Messprinzip dreht sich ein Magnetfeld um einen Hallsensor. Bei analoger Ausführung ist das System kurzschlussicher (bei unbegrenzter Kurzschlussdauer) gegen Spannungsversorgung.  
 J1 ist mit 16 PIN Molex Stecker (Micro Fit 3.0 housing 43025-1600) ausgerüstet.

The angular operating range is ±15°. The operating principle is non-contacting. Analogue: rotating magnetic field over hall-sensor. Short circuit-proof with analogue version (short circuit duration: unlimited) toward power supply.  
 J1 has a 16 PIN Molex connector (Micro Fit 3.0 housing 43025-1600).

Le débattement angulaire est ±15°. Le principe de mesure est sans contact. Analogue: champ magnétique tournant sur détecteur à effet Hall. Protégé contre les courts circuits avec version analogique (durée de court circuit: illimitée) envers l'alimentation.  
 J1 est équipé avec 16 broches Molex (Micro Fit 3.0 housing 43025-1600).

Kabelsätze siehe S. 131 (L2.D001A) / Cable sets see p. 131 (L2.D001A) / Câbles associés voir p. 131 (L2.D001A)

Änderungen und Irrtümer bleiben vorbehalten. Abbildungen ähnlich. Maßgeblich sind die dem ausgelieferten Produkt beigelegten technischen Dokumentationen. The relevant corresponding technical documents will be supplied with the product. Certain product descriptions can be similar therefore please ensure that you have the latest version of documentation for your specific product prior to any use. elobau reserves the right to change technical data and documentation without notice. Sous réserve de modifications et d'erreurs. Images similaires. Les documentations techniques accompagnant les produits sont d'application.

made  
in  
Germany

no CO<sub>2</sub>

Wir produzieren klimaneutral.  
 We produce in a carbon-neutral manner.  
 Nous produisons avec un bilan carbone neutre.

#### J1 ..... Joystickbasis – kleine Bauform

#### Joystick base – small version

#### Joystick – version miniature

J1 mit Knauf  
J1 with handle  
J1 avec pommeau

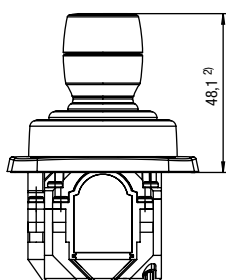

Einbau von unten, Verschraubung von oben  
bottom mount, screws on top  
montage par le dessous, vissage par le dessus

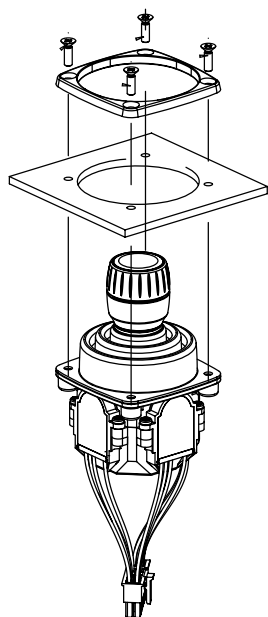

Einbauöffnung  
mounting hole  
trou de montage

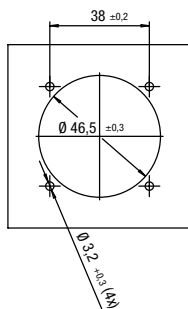

J1 mit Knauf und integrierter Taste  
J1 with handle and integrated button  
J1 avec pommeau et bouton intégré

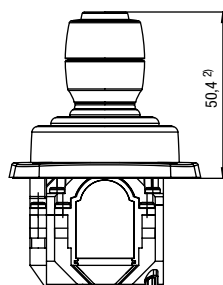

Einbau von unten, Verschraubung von unten  
bottom mount, screws at the bottom  
montage par le dessous, vissage par le dessous

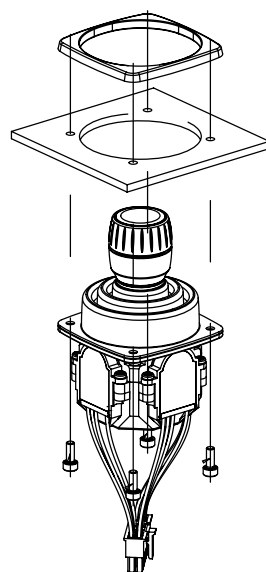

Einbauöffnung  
mounting hole  
trou de montage

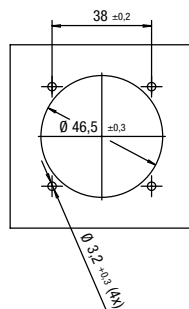

J1 mit Knauf und Z-Achse  
J1 with handle and z-axis  
J1 avec pommeau et axe z

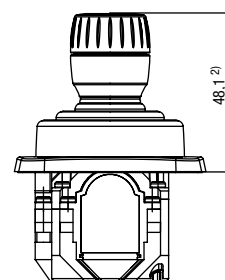

Einbau von oben, Verschraubung von oben  
top mount, screws on top  
montage par le dessus, vissage par le dessus

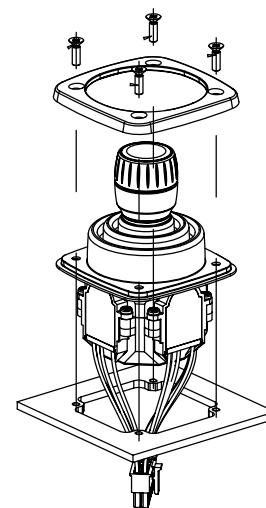

Einbauöffnung  
mounting hole  
trou de montage

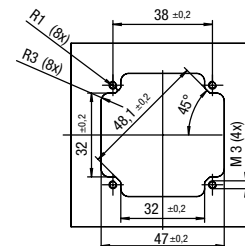

2) Einbau von oben  
2) top mount  
2) montage par le dessus

#### J1 ..... Joystickbasis – kleine Bauform

#### Joystick base – small version

#### Joystick – version miniature

Typen Nr. type no. référence	Betriebsspannung operating voltage tension d'alim.	Ausgangssignal output signal signal de sortie	Stromaufnahme current consumption consommation de courant	Lastwiderstand load resistance résistance de charge	Mittelstellung centre position zéro
J1 .....	4,5–5,5 V DC	0,5–4,5 V DC ratiom./proport.	max. 15 mA	> 20 kΩ	typ. 2,5 V

Typen Nr. type no. référence	Verpolschutz reverse connection protected protégé contre les inversions de polarité	Verzögerungszeit des Ausgangssignals delay time of output signal temps de retardement signal de sortie	Temperaturbereich temperature range plage de température	Schutzart protection class protection
J1 .....	ja/yes/oui	ca./approx./env. 3 ms	-25...+85°C mit Taste oder Z-Achse/push button switches or Z-axis/ avec boutons ou axe z -40...+85°C ohne Taste oder Z-Achse/without push button switches or z-axis/sans boutons ou axe z	Elektronik/ electronics/ électronique IP67

#### J1.6AA0.....

<p><b>Knauf mit Z-Achse</b> ZA1 = Ausgangssignal Z-Achse analog ZH1 = Ausgangssignal Z-Achse halb-redundant</p> <p><b>Knauf mit Drucktaste</b> TN1 = Namurbeschaltung TS1 = Schließer</p> <p><b>Knauf ohne Zusatzfunktion</b> K1 = Standardknauf</p> <p><b>Montageart</b> A = Einbau von unten, Verschraubung von oben B = Einbau von unten, Verschraubung von unten C = Einbau von oben, Verschraubung von oben</p> <p><b>Betätigung</b> 0 = multiaxial</p> <p><b>Endstellung Y-Achse</b> A = tastend</p> <p><b>Endstellung X-Achse</b> A = tastend</p> <p><b>Ausgangssignal</b> 6 = 0,5–4,5 V DC ratiometrisch</p> <p><b>Elektronik</b> A = analog H = analog halb-redundant R = redundand</p>	<p><b>handle with z-axis</b> ZA1 = output signal z-axis analogue ZH1 = output signal z-axis semi-redundant</p> <p><b>handle with push button</b> TN1 = Namur circuit TS1 = N.O.</p> <p><b>handle without additional function</b> K1 = standard handle</p> <p><b>Installation method</b> A = bottom mount, screws on top B = bottom mount, screws at the bottom C = top mount, screws on top</p> <p><b>actuation</b> 0 = multi-axial</p> <p><b>end position Y-axis</b> A = no detent</p> <p><b>end position X-axis</b> A = no detent</p> <p><b>output signal</b> 6 = 0,5–4,5 V DC ratiometric</p> <p><b>electronics</b> A = analogue H = analogue semi-redundant R = redundand</p>	<p><b>pommeau with axe z</b> ZA1 = signal de sortieaxe z analogique ZH1 = signal de sortie axe z semi-redundant</p> <p><b>pommeau avec bouton poussoir</b> TN1 = circuit de protection de Namur TS1 = NO</p> <p><b>pommeau sans fonction</b> K1 = pommeau standard</p> <p><b>manière de montage</b> A = montage par le dessous, vissage par le dessus B = montage par le dessous, vissage par le dessous C = montage par le dessus, vissage par le dessus</p> <p><b>levier (mouvements)</b> 0 = se déplace dans toutes les directions</p> <p><b>position extrêmes axe y</b> A = sans maintien</p> <p><b>position extrêmes axe x</b> A = sans maintien</p> <p><b>signal de sortie</b> 6 = 0,5–4,5 V DC ratiométrique</p> <p><b>type</b> A = analogique H = analogique semi-redundant R = redundand</p>
--	---	---

# Joystickbasis und Joystickgriffe

## Joystick base and Joystick handle

### Joystick et poignée



J2 .....

**Joystickbasis – kleine Bauform**  
**Joystick base – small version**  
**Joystick – version miniature**

SIL-capable EN61508	V <sub>out</sub> I <sub>out</sub>	U <sub>B</sub> 5 V	U <sub>B</sub> 30 V
48 V	IP 67	CAN	

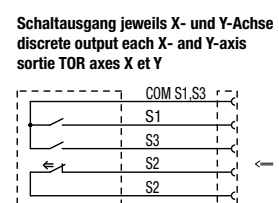
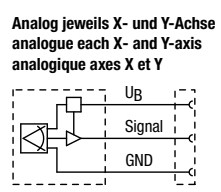
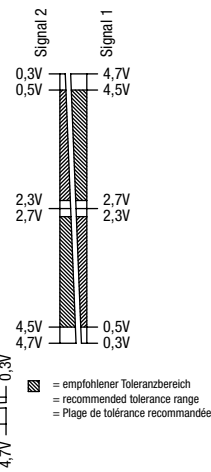
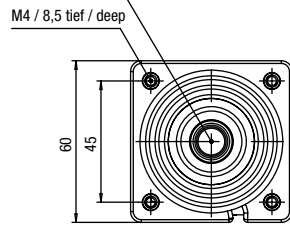
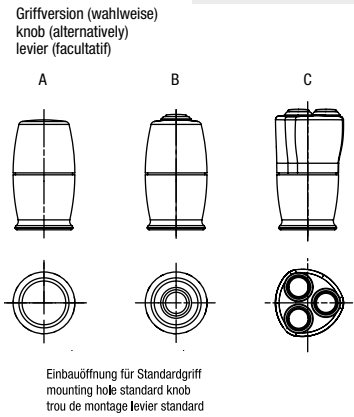
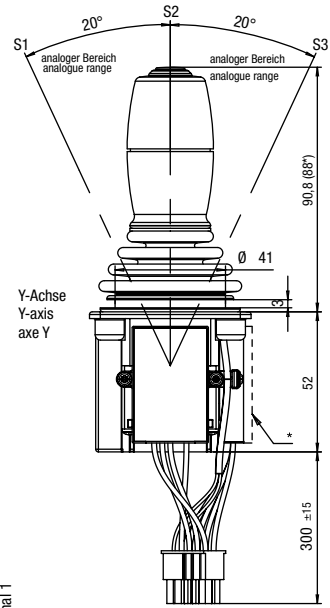
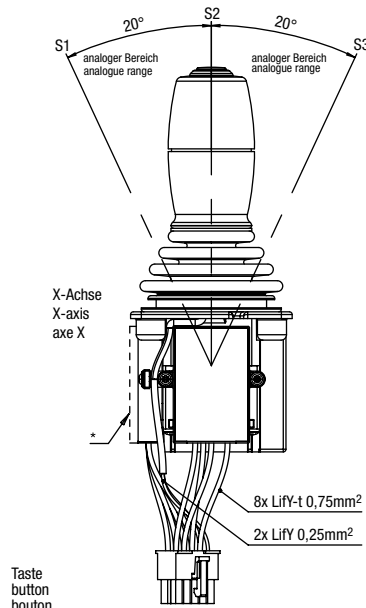

\* Aufbauhöhe für Ausführung Schaltausgang / Redundant / CAN  
 panel thickness for execution Switching output / redundant / CAN  
 dimension pour version TOR / redondante / CAN

U <sub>B</sub>	Signal	GND
WH1	WH2	WH3
RD	WH	BN

seit 2011  
since 2011  
depuis 2011

Com S1, S3	S1	S3	S2	S2
WH5	WH4	WH1	WH2	WH3
BN	BK	BU	WH	GY

seit 2011  
since 2011  
depuis 2011

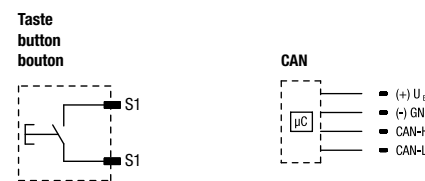

Nach Kundenspezifikation  
 According to customer specification  
 Selon spécification du client

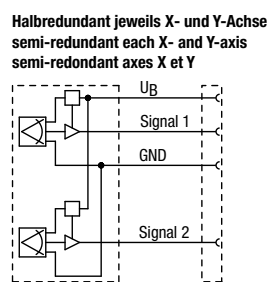

Nach Kundenspezifikation  
 According to customer specification  
 Selon spécification du client

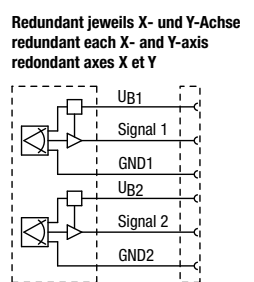

Nach Kundenspezifikation  
 According to customer specification  
 Selon spécification du client

Kabelsätze siehe S. 131 (L2.D001A)  
 Cable sets see p. 131 (L2.D001A)  
 Câbles associés voir p. 131 (L2.D001A)



# Joystickbasis und Joystickgriffe

## Joystick base and Joystick handle

### Joystick et poignée

#### J2 ..... Joystickbasis – kleine Bauform

#### Joystick base – small version

#### Joystick – version miniature

Der Winkelmessbereich beträgt  $\pm 20^\circ$ . Das Messprinzip ist kontaktlos. Beim analogen Messprinzip dreht sich ein Magnetfeld um einen Hallsensor, die Schaltausgangsvariante bedient sich der Reedtechnik. Bei analoger Ausführung ist das System kurzschlussicher (bei unbegrenzter Kurzschlussdauer). J2 ist mit 6/8/10- oder 12-PIN Molex 5557 Stecker ausgerüstet. Alternativen auf Anfrage.

The angular operating range is  $\pm 20^\circ$ . The operating principle is non-contacting:  
 – analogue: rotating magnetic field over hall-sensor  
 – discrete output: reed technique  
 Short circuit-proof with analogue version (short circuit duration: unlimited).  
 J2 has a 6/8/10 or 12 PIN Molex 5557 connector, alternatives on request.

Le débattement angulaire est  $\pm 20^\circ$ . Le principe de mesure est sans contact:  
 – analogue: champ magnétique tournant sur détecteur à effet Hall  
 – sortie TOR: technique Reed  
 Protégé contre les courts circuits avec version analogue (durée de court circuit: illimitée).  
 J2 est équipé avec 6/8/10 ou 12 broches Molex 5557, alternative sur demande.

analog analogue analogique	Typen Nr. type no. référence	Betriebsspannung operating voltage tension d'alim.	Ausgangssignal output signal signal de sortie	Stromaufnahme current consumption consommation de courant	Lastwiderstand load resistance résistance de charge	Mittelstellung centre position zéro
	J2 A1....	10–30 V DC	4–20 mA	bei 12 V max. 18 mA	10 V < 250 $\Omega$ 30 V < 1250 $\Omega$	12 mA
	J2 A6....	4,5–5,5 V DC	0,5–4,5 V DC ratiom./proport.	max. 15 mA	> 20 k $\Omega$	typ. 2,5 V
	J2 A7....	10–30 V DC	0,5–4,5 V DC	bei 12 V max. 15 mA	> 20 k $\Omega$	typ. 2,5 V

Schaltausgang discrete output sortie TOR	Typen Nr. type no. référence	Schaltspannung switching voltage tension de commut.	Schaltstrom switching current courant de commut.	Schaltleistung switching power pouvoir de coupure	Kontaktart contact form forme de contact	CAN-Bus und PWM-Signale CAN-Bus and PWM signals réseau CAN et signaux PWM
	J2 D8.....	max. 48 V	max. 0,3 A	max. 10 W / 10 VA	3 x Schließer / 3 x N.O. / 3 x NO	auf Anfrage/on request/sur demande

Typen Nr. type no. référence	Verpolschutz reverse connection protected protégé contre les inversions de polarité	Verzögerungszeit des Ausgangssignals delay time of output signal temps de retardement signal de sortie	Temperaturbereich temperature range plage de température	Schutzart protection class protection
J2 .....	ja/yes/oui	ca./approx./env. 3 ms	-25..+85°C mit Taste/ with push button switches/avec boutons -40...+85°C ohne Taste/ without push button switches/sans boutons	Elektronik/electronics/ électronique IP67

Microtaste mini push button bouton poussoir miniature	Schaltspannung switching voltage tension de commut.	Schaltstrom switching current courant de commut.	Schaltleistung switching power pouvoir de coupure	Kontaktart contact form forme de contact	Tastenhub push button stroke course du bouton
Für B + C For B + C Pour B + C	max. 48 V	max. 0,5 A	max. 10 W / 10 VA	Schließer / N.O. / NO	2,5 mm

Kabelsätze siehe S. 131 (L2.D001A)  
 Cable sets see p. 131 (L2.D001A)  
 Câbles associés voir p. 131 (L2.D001A)

Änderungen und Irrtümer bleiben vorbehalten. Abbildungen ähnlich. Maßgeblich sind die dem ausgelieferten Produkt beigelegten technischen Dokumentationen.  
 The relevant corresponding technical documents will be supplied with the product. Certain product descriptions can be similar therefore please ensure that you have the latest version of documentation for your specific product prior to any use. elobau reserves the right to change technical data and documentation without notice.  
 Sous réserve de modifications et d'erreurs. Images similaires. Les documentations techniques accompagnant les produits sont d'application.



Wir produzieren klimaneutral.  
 We produce in a carbon-neutral manner.  
 Nous produisons avec un bilan carbone neutre.

## J2 ..... Joystickbasis – kleine Bauform

### Joystick base – small version

### Joystick – version miniature

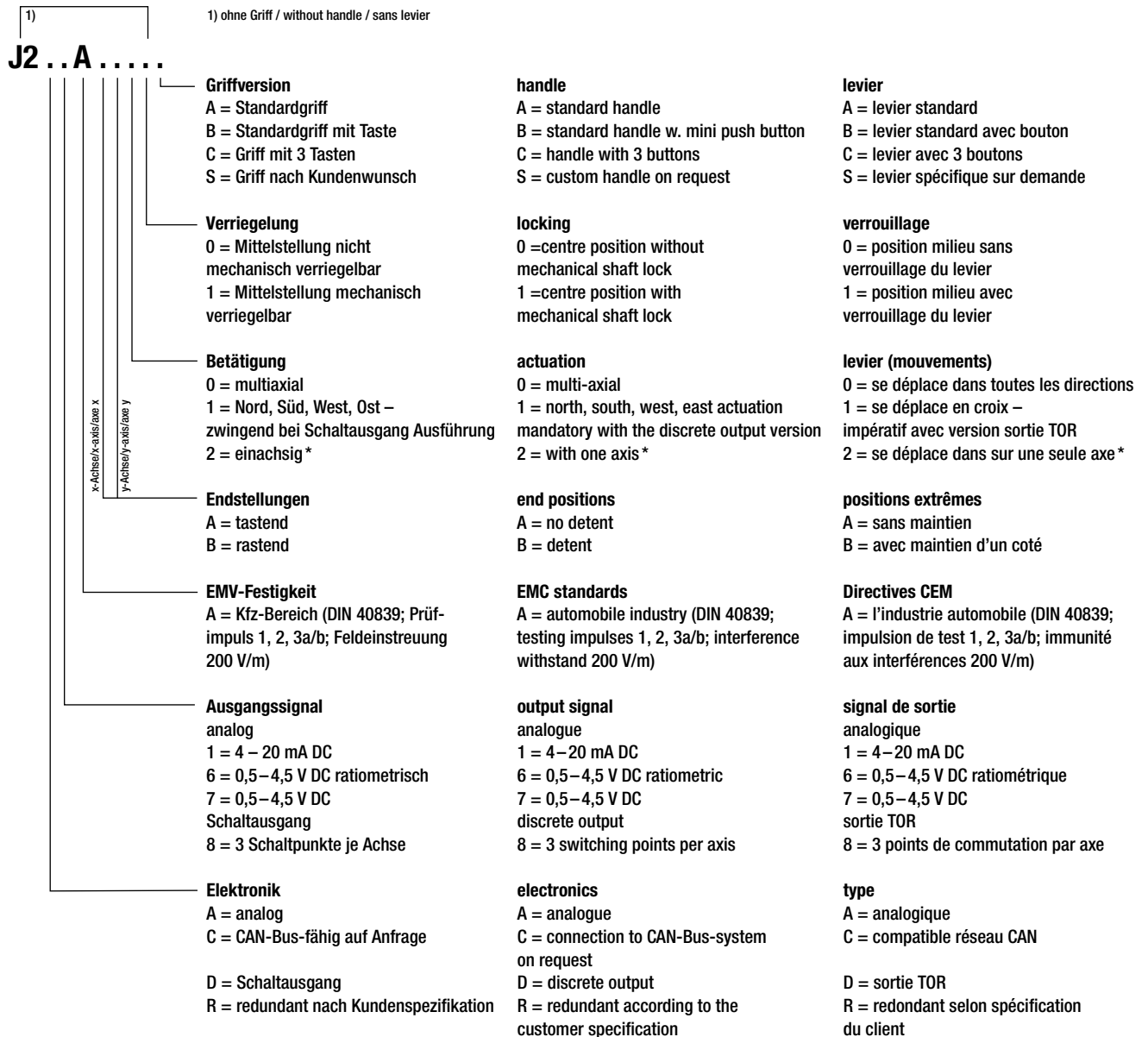

\* Achtung: bei einachsiger Ausführung entfällt bei der Typennummer eine Stelle (s. untenstehendes Bestellbeispiel).  
Please note: when only one axis is required the type number has only 9 digits (like shown below in the ordering example).  
Attention: dans ce cas la référence du produit comporte 9 chiffres au lieu de 10 (voir exemple ci-dessous).

**Bestellbeispiel**  
einachsige: J 2 A 7 A A 2 0 A  
zweiachsige: J 2 A 7 A A A 0 0 A

**ordering example**  
1 axis: J 2 A 7 A A 2 0 A  
2 axis: J 2 A 7 A A A 0 0 A

**exemple de commande**  
1 axe: J 2 A 7 A A 2 0 A  
2 axe: J 2 A 7 A A A 0 0 A

Kabelsätze siehe S. 131 (L2.D001A)  
Cable sets see p. 131 (L2.D001A)  
Câbles associés voir p. 131 (L2.D001A)

# Joystickbasis und Joystickgriffe

## Joystick base and Joystick handle

### Joystick et poignée

J3 .....

**Joystickbasis – einachsig**  
**Joystick base – single axis**  
**Joystick – un axe**

SIL-capable EN61508	U <sub>B</sub> 5 V	U <sub>B</sub> 30 V	V <sub>out</sub> I <sub>out</sub>
	U <sub>B</sub> 48 V	IP 67	CAN

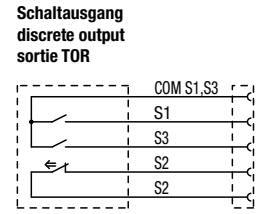
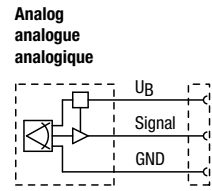
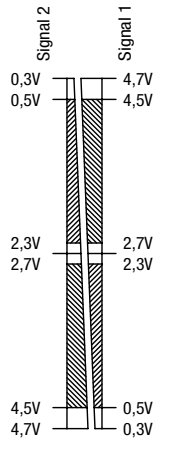
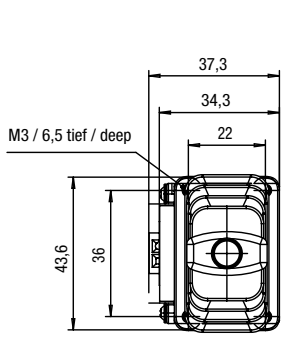
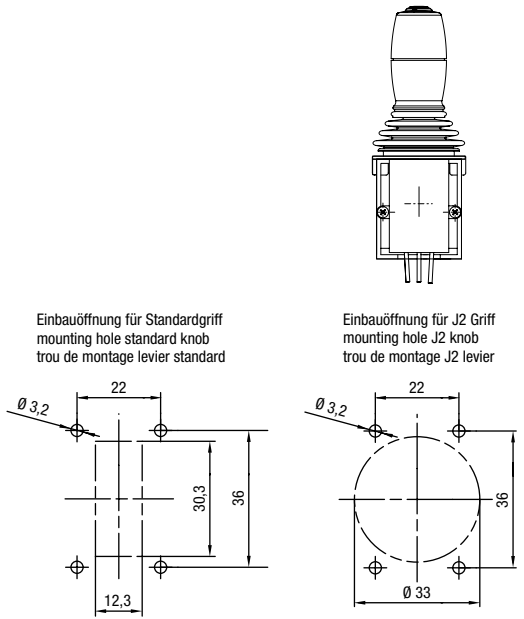
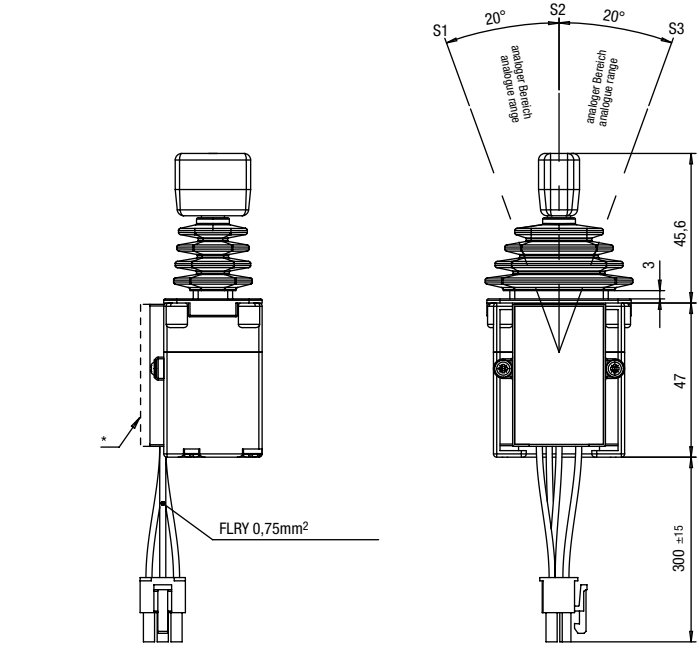

ub	Signal	GND	
WH1	WH2	WH3	seit 2011 since 2011 depuis 2011
RD	WH	BN	

Com S1, S3	S1	S3	S2	S2	
WH5	WH4	WH1	WH2	WH3	seit 2011 since 2011 depuis 2011
BN	BK	BU	WH	GY	

\* Aufbauhöhe für Ausführung Schaltausgang / Redundant / CAN  
 panel thickness for execution Switching output / redundant / CAN  
 dimension pour version TOR / redondante / CAN

☐ = empfohlener Toleranzbereich  
 = recommended tolerance range  
 = Plage de tolérance recommandée

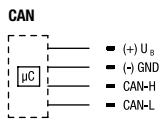

Nach Kundenspezifikation  
 According to customer specification  
 Selon spécification du client

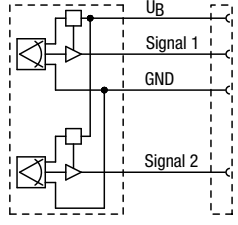

**Halbredundant**  
**semi-redundant**  
**semi-redondant**  
 Nach Kundenspezifikation  
 According to customer specification  
 Selon spécification du client

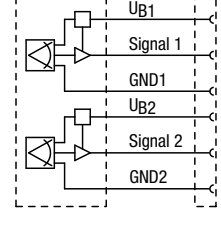

**Redundant**  
**redundant**  
**redondant**  
 Nach Kundenspezifikation  
 According to customer specification  
 Selon spécification du client

Der Winkelmessbereich beträgt ±20° (25°).  
 Das Messprinzip ist kontaktlos. Beim analogen Messprinzip dreht sich ein Magnetfeld um einen Hallsensor, die Schaltausgangsvariante bedient sich der Reedtechnik.  
 Bei analoger Ausführung ist das System kurzschlussicher (bei unbegrenzter Kurzschlussdauer). J3 ist mit 4-PIN Molex 5557 Stecker ausgerüstet. Alternativen auf Anfrage.

The angular operating range is ±20° (25°).  
 The operating principle is non-contacting:  
 – analogue: rotating magnetic field over hall-sensor  
 – discrete output: reed technique  
 Short circuit-proof with analogue version (short circuit duration: unlimited). J3 has a 4 PIN Molex 5557 connector, alternatives on request.

Le débattement angulaire est ±20° (25°).  
 Le principe de mesure est sans contact:  
 – analogue: champ magnétique tournant sur détecteur à effet Hall  
 – sortie TOR: technique Reed  
 Protégé contre les courts circuits avec version analogique (durée de court circuit: illimitée). J3 est équipé avec 4 broches Molex 5557, alternative sur demande.

Kabelsätze siehe S. 131 (L2.D001A) / Cable sets see p. 131 (L2.D001A) / Câbles associés voir p. 131 (L2.D001A)  
 Änderungen und Irrtümer bleiben vorbehalten. Abbildungen ähnlich. Maßgeblich sind die dem ausgelieferten Produkt beigelegten technischen Dokumentationen.  
 The relevant corresponding technical documents will be supplied with the product. Certain product descriptions can be similar therefore please ensure that you have the latest version of documentation for your specific product prior to any use. elobau reserves the right to change technical data and documentation without notice.  
 Sous réserve de modifications et d'erreurs. Images similaires. Les documentations techniques accompagnant les produits sont d'application.

**J3 .....**      **Joystickbasis – einachsig**  
**Joystick base – single axis**  
**Joystick – un axe**

analog analogue analogique	Typen Nr. type no. référence	Betriebsspannung operating voltage tension d'alim.	Ausgangssignal output signal signal de sortie	Stromaufnahme current consumption consommation de courant	Lastwiderstand load resistance résistance de charge	Mittelstellung centre position zéro
	J3 A1...	10–30 V DC	4–20 mA	bei 12 V max. 18 mA	10 V < 250 Ω 30 V < 1250 Ω	12 mA
	J3 A6...	4,5–5,5 V DC	0,5–4,5 V DC ratiom./propor.	max. 15 mA	> 20 kΩ	typ. 2,5 V
	J3 A7...	10–30 V DC	0,5–4,5 V DC	bei 12 V max. 15 mA	> 20 kΩ	typ. 2,5 V

Schaltausgang discrete output sortie TOR	Typen Nr. type no. référence	Schaltspannung switching voltage tension de commut.	Schaltstrom switching current courant de commut.	Schaltleistung switching power pouvoir de coupure	Kontaktart contact form forme de contact	CAN-Bus und PWM-Signale CAN-Bus and PWM signals réseau CAN et signaux PWM
	J3 D8...	max. 48 V	max. 0,3 A	max. 10 W / 10 VA	3 x Schließer / 3 x N.O. / 3 x NO	auf Anfrage/on request/sur demande

Typen Nr. type no. référence	Verpolschutz reverse connection protected protégé contre les inversions de polarité	Verzögerungszeit des Ausgangssignals delay time of output signal temps de retardement signal de sortie	Temperaturbereich temperature range plage de température	Schutzart protection class protection
J3 .....	ja/yes/oui	ca./approx./env. 3 ms <sup>2)</sup>	-25...+85°C mit Taste/ with push button swit- ches/avec boutons -40...+85°C ohne Taste/ without push button switches/sans boutons	Elektronik/electronics/ électronique IP67

2) nur bei analoger Ausführung / analogue version only / seulement avec version analogique

Kabelsätze siehe S. 131 (L2.D001A)  
 Cable sets see p. 131 (L2.D001A)  
 Câbles associés voir p. 131 (L2.D001A)

**J3 .....** Joystickbasis – einachsig  
 Joystick base – single axis  
 Joystick – un axe

1) ohne Griff / without handle / sans levier

**J3 . . . A . . .**

**Griffversion**  
 A = Standardgriff  
 S = Griff nach Kundenwunsch

**Verriegelung**  
 0 = Mittelstellung nicht  
 mechanisch verriegelbar  
 1 = Mittelstellung mechanisch  
 verriegelbar\*\*

**Endstellungen**  
 A = tastend 20°  
 B = rastend 20°  
 C = tastend 25°  
 D = rastend 25°  
 F = Reibbremse 20° \*

**EMV-Festigkeit**  
 A = Kfz-Bereich (DIN 40839; Prüf-  
 impuls 1, 2, 3a/b; Feldeinstreuung  
 200 V/m)

**Ausgangssignal**  
 analog  
 1 = 4 – 20 mA DC  
 6 = 0,5–4,5 V DC ratiometrisch  
 7 = 0,5–4,5 V DC  
 Schaltausgang  
 8 = 3 Schaltpunkte je Achse

**Elektronik**  
 A = analog  
 C = CAN-Bus-fähig auf Anfrage  
  
 D = Schaltausgang  
 R = redundant

\* Nicht in Kombination mit:  
 – J2-Griff  
 – Mittelstellung mechanisch  
 verriegelbar

\*\* In Kombination mit  
 Standardgriff

**handle**  
 A = standard handle  
 S = custom handle on request

**locking**  
 0 = centre position without  
 mechanical shaft lock  
 1 = centre position with  
 mechanical shaft lock\*\*

**end positions**  
 A = no detent 20°  
 B = detent 20°  
 C = no detent 25°  
 D = detent 25°  
 F = friction brake 20° \*

**EMC standards**  
 A = automobile industry (DIN 40839;  
 testing impulses 1, 2, 3a/b; interference  
 withstand 200 V/m)

**output signal**  
 analogue  
 1 = 4–20 mA DC  
 6 = 0,5–4,5 V DC ratiometric  
 7 = 0,5–4,5 V DC  
 discrete output  
 8 = 3 switching points per axis

**electronics**  
 A = analogue  
 C = connection to CAN-Bus-system  
 on request  
 D = discrete output  
 R = redundant

\* Not in combination with:  
 – J2-handle  
 – centre position with mechanical  
 shaft lock

\*\* In combination with  
 standard handle

**levier**  
 A = levier standard  
 S = levier spécifique sur demande

**verrouillage**  
 0 = position milieu sans  
 verrouillage du levier  
 1 = position milieu avec  
 verrouillage du levier\*\*

**positions extrêmes**  
 A = sans maintien 20°  
 B = avec maintien d'un coté 20°  
 C = sans maintien 25°  
 D = avec maintien d'un coté 25°  
 F = mécanisme de friction 20° \*

**Directives CEM**  
 A = l'industrie automobile (DIN 40839;  
 impulsion de test 1, 2, 3a/b; immunité  
 aux interférences 200 V/m)

**signal de sortie**  
 analogique  
 1 = 4–20 mA DC  
 6 = 0,5–4,5 V DC ratiométrique  
 7 = 0,5–4,5 V DC  
 sortie TOR  
 8 = 3 points de commutation par axe

**type**  
 A = analogique  
 C = compatible réseau CAN  
  
 D = sortie TOR  
 R = redundant

\* combinaison non réalisable avec:  
 – levier J2  
 – position milieu avec verrouillage du levier

\*\* Combinaison réalisable avec  
 levier standard

Kabelsätze siehe S. 131 (L2.D001A)  
 Cable sets see p. 131 (L2.D001A)  
 Câbles associés voir p. 131 (L2.D001A)

Änderungen und Irrtümer bleiben vorbehalten. Abbildungen ähnlich. Maßgeblich sind die dem ausgelieferten Produkt beigelegten technischen Dokumentationen.  
 The relevant corresponding technical documents will be supplied with the product. Certain product descriptions can be similar therefore please ensure that you have  
 the latest version of documentation for your specific product prior to any use. elobau reserves the right to change technical data and documentation without notice.  
 Sous réserve de modifications et d'erreurs. Images similaires. Les documentations techniques accompagnant les produits sont d'application.

# Joystickbasis und Joystickgriffe

## Joystick base and Joystick handle

### Joystick et poignée

J6 .....

**Joystickbasis – kompakte Bauform**  
**Joystick base – compact design**  
**Joystick – version compacte**

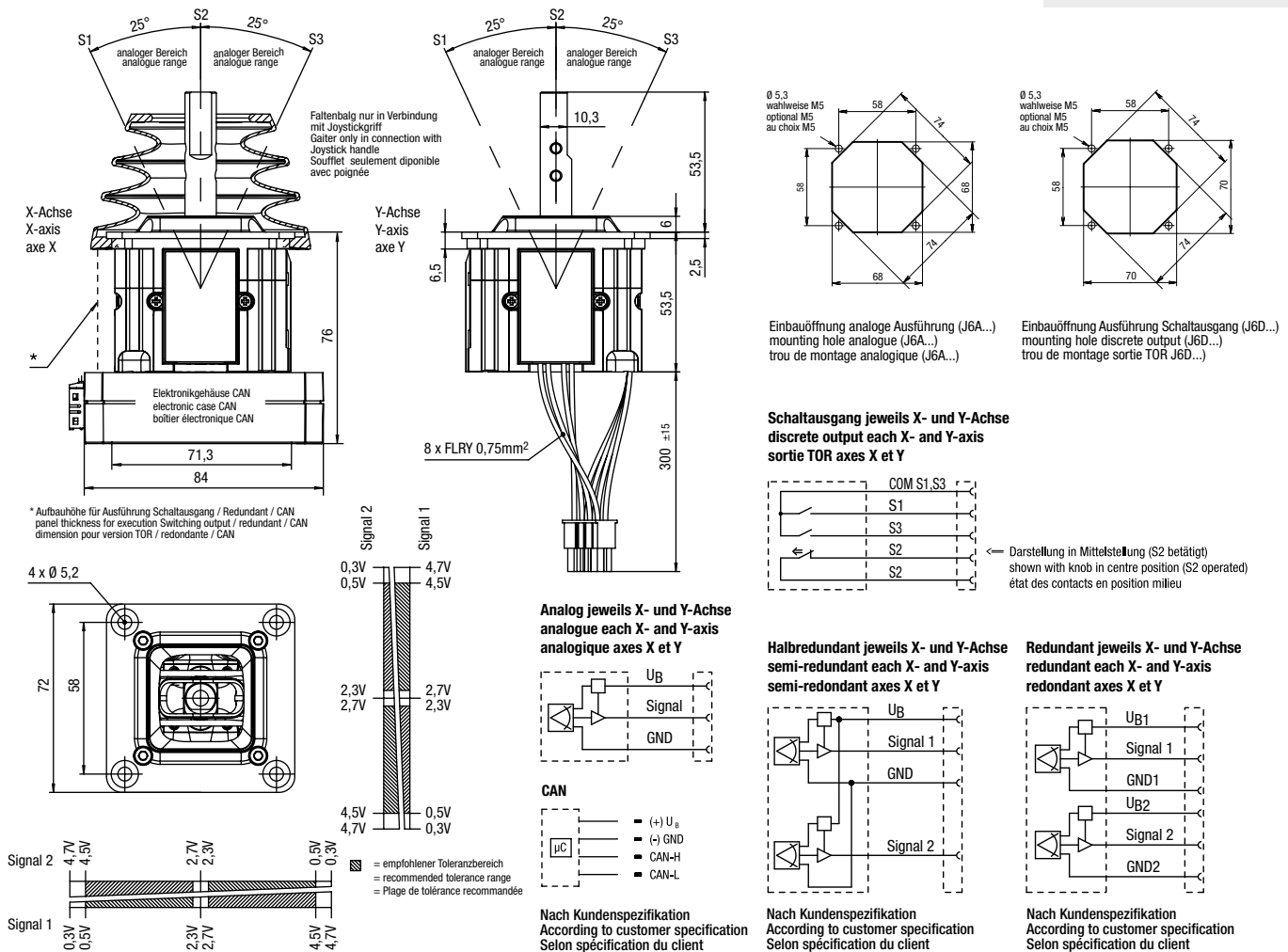

Der Winkelmessbereich beträgt  $\pm 25^\circ$  ( $\pm 20^\circ$ ). Das Messprinzip ist kontaktlos. Beim analogen Messprinzip dreht sich ein Magnetfeld um einen Hallsensor, die Schaltausgangsvariante bedient sich der Reedtechnik. Bei analoger Ausführung ist das System kurzschlussicher (bei unbegrenzter Kurzschlussdauer). Der J6 ist mit 6/8/10- od. 12-PIN Molex 5557 Stecker ausgerüstet. Die statische Belastbarkeit (max. 150 mm vom Drehpunkt entfernt) beträgt bei der x- und y-Achse 750 N, bei der z-Achse 500 N. Mechanische Lebensdauer:  $8 \times 10^6$  Betätigungen entspricht  $2 \times 10^6$  elobau Testzyklen.

The angular operating range is  $\pm 25^\circ$  ( $\pm 20^\circ$ ). The operating principle is non-contacting: – analogue: rotating magnetic field over hall-sensor – discrete output: reed technique Short circuit-proof with analogue version (short circuit duration: unlimited). The J6 has a 6/8/10 or 12 PIN Molex 5557 connector. The static loading capacity (max. 150 mm from the point of rotation) is 750 N in the x and y axis, and 500 N in the z axis. Mechanical life:  $8 \times 10^6$  operations equates  $2 \times 10^6$  elobau cycles.

Le débattement angulaire est  $\pm 25^\circ$  ( $\pm 20^\circ$ ). Le principe de mesure est sans contact: – analogue: champ magnétique tournant sur détecteur à effet Hall – sortie TOR: technique Reed Protégé contre les courts circuits avec version analogue (durée de court circuit: illimitée). Le J6 a équipés avec 6/8/10 ou 12 broches Molex 5557. La force horizontale maximale pouvant être appliqué sur le levier (à 150 mm de l'axe de rotation) est de 750 N suivant les deux axes x, y. Longévité mécanique:  $8 \times 10^6$  opérations correspond à  $2 \times 10^6$  cycles.

Kabelsätze siehe S. 131 (L2.D001A)  
Cable sets see p. 131 (L2.D001A)  
Câbles associés voir p. 131 (L2.D001A)

# Joystickbasis und Joystickgriffe

## Joystick base and Joystick handle

### Joystick et poignée

#### J6 ..... Joystickbasis – kompakte Bauform

#### Joystick base – compact design

#### Joystick – version compacte

Standardgriff ohne Microtaste  
Standard handle without micro push button  
Poignée standard sans boutons

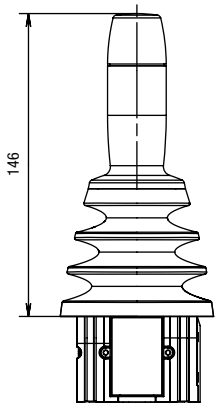

Standardgriff mit Microtaste  
Standard handle with micro push button  
Poignée standard avec boutons

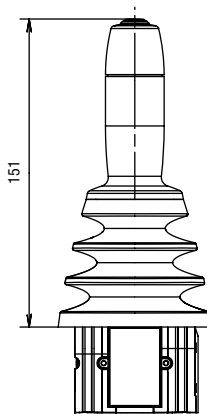

3-Tasten-Griff – max. 3 Microtasten  
3-button handle – max. 3 micro push buttons  
Poignée à 3 boutons – max. 3 boutons

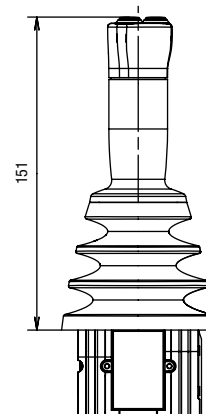

J6 Joystick mit Multifunktionsgriff 341G...  
J6 joystick with multi function lever 341G...  
J6 joystick avec Pommeau multifonctions 341G...

Daumenrad A  
thumbwheel A  
molette A

Taste 4  
pushbutton 4  
bouton 4

Taste 5  
pushbutton 5  
bouton 5

25°

25°

Faltenbalg  
gaiter  
soufflet

X-Achse  
x axis  
axe x

Multifunktionsgriff  
multi function lever  
pommeau multifonctions

Y-Achse  
y axis  
axe y

Robustjoystick Basis  
joystick base  
joystick

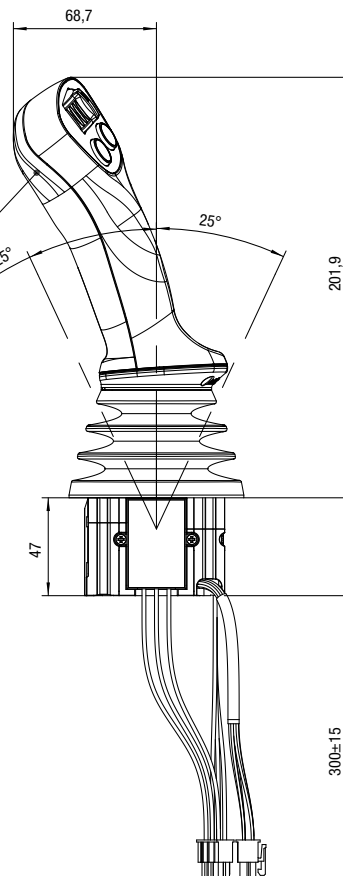

Kabelsätze siehe S. 131 (L2.D001A)  
Cable sets see p. 131 (L2.D001A)  
Câbles associés voir p. 131 (L2.D001A)

Änderungen und Irrtümer bleiben vorbehalten. Abbildungen ähnlich. Maßgeblich sind die dem ausgelieferten Produkt beigelegten technischen Dokumentationen.  
The relevant corresponding technical documents will be supplied with the product. Certain product descriptions can be similar therefore please ensure that you have the latest version of documentation for your specific product prior to any use. elobau reserves the right to change technical data and documentation without notice.  
Sous réserve de modifications et d'erreurs. Images similaires. Les documentations techniques accompagnant les produits sont d'application.

**J6 .....**      **Joystickbasis – kompakte Bauform**  
**Joystick base – compact design**  
**Joystick – version compacte**

analog analogue analogique	Typen Nr. type no. référence	Betriebsspannung operating voltage tension d'alim.	Ausgangssignal output signal signal de sortie	Stromaufnahme current consumption consommation de courant	Lastwiderstand load resistance résistance de charge	Mittelstellung centre position zéro
	J6 A1.....	10–30 V DC	4–20 mA	bei 12 V max. 18 mA	10 V < 250 Ω 30 V < 1250 Ω	12 mA
	J6 A6.....	4,5–5,5 V DC	0,5–4,5 V DC ratiom./propor.	max. 15 mA	> 20 kΩ	typ. 2,5 V
	J6 A7.....	10–30 V DC	0,5–4,5 V DC	bei 12 V max. 15 mA	> 20 kΩ	typ. 2,5 V

Schaltausgang discrete output sortie TOR	Typen Nr. type no. référence	Schaltspannung switching voltage tension de commut.	Schaltstrom switching current courant de commut.	Schaltleistung switching power pouvoir de coupure	Kontaktart contact form forme de contact	CAN-Bus und PWM-Signale CAN-Bus and PWM signals réseau CAN et signaux PWM
	J6 D8.....	max. 48 V	max. 0,3 A	max. 10 W / 10 VA	3 x Schließer/ 3xN.O. / 3xNO	auf Anfrage/on request/sur demande

Typen Nr. type no. référence	Verpolschutz reverse connection protected protégé contre les inversions de polarité	Verzögerungszeit des Ausgangssignals delay time of output signal temps de retardement signal de sortie	Temperaturbereich temperature range plage de température	Schutzart protection class protection
J6 .....	ja/yes/oui	ca./approx./env. 3 ms	-25...+85°C mit Taste/ with push button switches/avec boutons -40...+85°C ohne Taste/ without push button switches/sans boutons	Elektronik/electronics/ électronique IP67

Microtaste mini push button bouton poussoir miniature	Schaltspannung switching voltage tension de commut.	Schaltstrom switching current courant de commut.	Schaltleistung switching power pouvoir de coupure	Kontaktart contact form forme de contact	Tastenhub push button stroke course du bouton
Für / for / pour B+C	max. 48 V	max. 0,5 A	max. 10 W / 10 VA	Schließer / N.O. / NO	2,5 mm

Nanotaste nano push button bouton poussoir nano	Schaltspannung switching voltage tension de commut.	Schaltstrom switching current courant de commut.	Schaltleistung switching power pouvoir de coupure	Kontaktart contact form forme de contact	Tastenhub push button stroke course du bouton
Für / for / pour G	max. 48 V	max. 0,3 A	max. 5 W / 5 VA	Schließer / N.O. / NO	2,15 mm

Kabelsätze siehe S. 131 (L2.D001A)  
Cable sets see p. 131 (L2.D001A)  
Câbles associés voir p. 131 (L2.D001A)



## J6 ..... Joystickbasis – kompakte Bauform Joystick base – compact design Joystick – version compacte

<p>1) 2)</p> <p><b>J6 ... AAA. 0 ...</b></p> <p>x-Achse/x-axis/axe x y-Achse/y-axis/axe y</p>	<p>1) Joystick mit montiertem Multifunktionsgriff Joystick with multifunctional lever mounted Joystick avec pommeau multifonctions monté</p>	<p>2) ohne Multifunktionsgriff without multifunctional lever sans pommeau pommeau multifonctions</p>
<p><b>Griffversion</b> A = Standardgriff B = Standardgriff mit Taste C = Griff mit 3 Tasten S = Griff nach Kundenwunsch G = Multifunktionsgriff</p> <p><b>Verriegelung</b> 0 = Mittelstellung nicht mechanisch verriegelbar</p> <p><b>Betätigung</b> 0 = multiaxial 1 = Nord, Süd, West, Ost – zwingend bei Schaltausgang Ausführung 2 = einachsigt*</p> <p><b>Endstellungen</b> A = tastend</p> <p><b>EMV-Festigkeit</b> A = Kfz-Bereich (DIN 40839; Prüfimpuls 1, 2, 3a/b; Feldeinstreuung 200 V/m)</p> <p><b>Ausgangssignal</b> analog 1 = 4–20 mA DC 6 = 0,5–4,5 V DC ratiometrisch 7 = 0,5–4,5 V DC Schaltausgang 8 = 3 Schaltpunkte je Achse</p> <p><b>Elektronik</b> A = analog C = CAN-Bus-fähig auf Anfrage  D = Schaltausgang R = redundant</p> <p>* Achtung: bei einachsiger Ausführung entfällt bei der Typennummer eine Stelle (s. unten stehendes Bestellbeispiel.)</p> <p><b>Bestellbeispiel</b> J6A6AAA00 = multiaxial J6A6AAA10 = Nord, Süd, West, Ost J6A6AA20 = einachsigt</p>	<p><b>handle</b> A = standard handle B = standard handle w. mini push button C = handle with 3 push buttons S = custom handle on request G = multifunction handle</p> <p><b>locking</b> 0 = centre position without mechanical shaft lock</p> <p><b>actuation</b> 0 = multi-axial 1 = north, south, west, east actuation mandatory with the discrete output version 2 = single axis*</p> <p><b>end positions</b> A = no detent</p> <p><b>EMC standards</b> A = automobile industry (DIN 40839; testing impulses 1, 2, 3a/b; interference withstand 200 V/m)</p> <p><b>output signal</b> analogue 1 = 4–20 mA DC 6 = 0,5–4,5 V DC ratiometric 7 = 0,5–4,5 V DC discrete output 8 = 3 switching points per axis</p> <p><b>electronics</b> A = analogue C = connection to CAN-Bus-system on request D = discrete output R = redundant</p> <p>* Please note: when only one axis is required the type number has only 9 digits (like shown below in the ordering example.)</p> <p><b>ordering example</b> J6A6AAA00 = multi-axial J6A6AAA10 = north, south, west, east actuation J6A6AA20 = single axis</p>	<p><b>levier</b> A = levier standard B = levier standard avec bouton C = levier avec 3 boutons S = levier spécifique sur demande G = pommeau multifonctions</p> <p><b>verrouillage</b> 0 = position milieu sans verrouillage du levier</p> <p><b>levier (mouvements)</b> 0 = se déplace dans toutes les directions 1 = se déplace en croix – impératif avec version sortie TOR 2 = un axe*</p> <p><b>positions extrêmes</b> A = sans maintien</p> <p><b>Directives CEM</b> A = l'industrie automobile (DIN 40839; impulsion de test 1, 2, 3a/b; immunité aux interférences 200 V/m)</p> <p><b>signal de sortie</b> analogique 1 = 4–20 mA DC 6 = 0,5–4,5 V DC ratiométrique 7 = 0,5–4,5 V DC sortie TOR 8 = 3 points de commutation par axe</p> <p><b>type</b> A = analogique C = compatible réseau CAN  D = sortie TOR R = redondant</p> <p>* Attention: dans ce cas la référence du produit comporte 9 chiffres au lieu de 10 (voir exemple ci-dessous.)</p> <p><b>exemple de commande</b> J6A6AAA00 = se déplace dans toutes les directions J6A6AAA10 = se déplace en croix J6A6AA20 = un axe</p>

Kabelsätze siehe S. 131 (L2.D001A)  
Cable sets see p. 131 (L2.D001A)  
Câbles associés voir p. 131 (L2.D001A)

Änderungen und Irrtümer bleiben vorbehalten. Abbildungen ähnlich. Maßgeblich sind die dem ausgelieferten Produkt beigelegten technischen Dokumentationen.  
The relevant corresponding technical documents will be supplied with the product. Certain product descriptions can be similar therefore please ensure that you have the latest version of documentation for your specific product prior to any use. elobau reserves the right to change technical data and documentation without notice.  
Sous réserve de modifications et d'erreurs. Images similaires. Les documentations techniques accompagnant les produits sont d'application.

made  
in  
Germany

no CO<sub>2</sub>

Wir produzieren klimaneutral.  
We produce in a carbon-neutral manner.  
Nous produisons avec un bilan carbone neutre.



# Joystickbasis und Joystickgriffe

## Joystick base and Joystick handle

### Joystick et poignée

J5 .....

**Robustjoystickbasis Einbau von unten**  
**Heavy duty joystick base for bottom mount**  
**Joystick robuste montage par le bas**

SIL-capable EN61508	U <sub>B</sub> 30 V	V <sub>out</sub> I <sub>out</sub>
48 V	IP 67	CAN

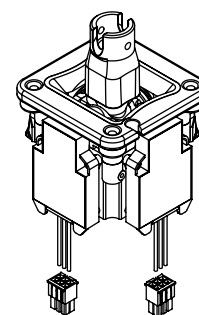
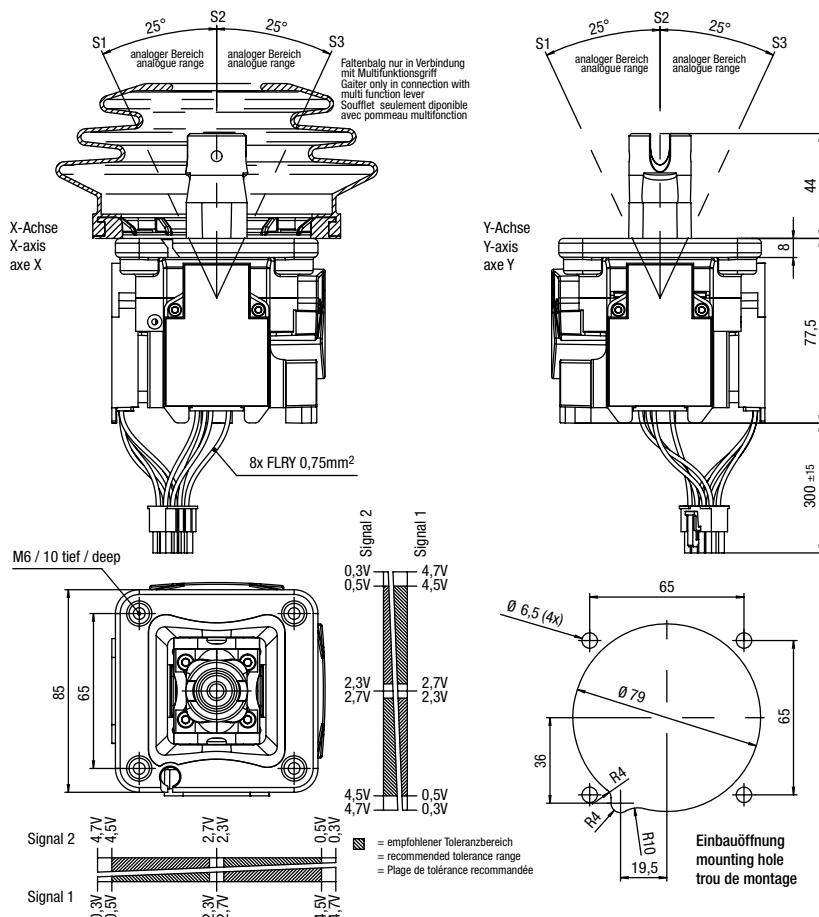

Der Winkelmessbereich beträgt ± 25° (± 20° + ± 15°). Das Messprinzip ist kontaktlos. Beim analogen Messprinzip dreht sich ein Magnetfeld um einen Hallsensor, die Schaltungsausgangsvариante bedient sich der Reedtechnik. Bei analoger Ausführung ist das System kurzschlussicher (bei unbegrenzter Kurzschlussdauer). J4 und J5 sind mit 6/8/10- od. 12-PIN Molex 5557 Stecker ausgerüstet. Mit Elektronikgehäuse z.B. für CAN- od. PWM-Signal erfolgt der Anschluss mit AMP 040 Multi-Lock 8-pins. Alternativen auf Anfrage. Kräfte auf Anfrage. Die statische Belastbarkeit (max. 190 mm vom Drehpunkt entfernt) beträgt in der x- und y-Achse 2000 N, in der z-Achse 700 N. Mechanische Lebensdauer: 8 x 10<sup>6</sup> Betätigungen entspricht 2 x 10<sup>6</sup> elobau Testzyklen.

The angular operating range is ± 25° (± 20° + ± 15°). The operating principle is non-contacting:  
 – analogue: rotating magnetic field over hall-sensor  
 – discrete output: Reed technique  
 Short circuit-proof with analogue version (short circuit duration: unlimited).  
 J4 and J5 have a 6/8/10 or 12 PIN Molex 5557 connector. The electronic housing for CAN or PWM signals is fitted with an AMP 040 Multi-lock 8-pin connector. Alternatives on request. Forces on request.  
 The static loading capacity (max. 190 mm from the point of rotation) is 2000 N in the x and y axis, and 700 N in the z axis.  
 Lifetime of 8 x 10<sup>6</sup> operations corresponds to 2 x 10<sup>6</sup> elobau test cycles.

Le débattement angulaire est ± 25° (± 20° + ± 15°). Le principe de mesure est sans contact: – analogique: champ magnétique tournant sur détecteur à effet Hall  
 – sortie TOR: technique Reed  
 Protégé contre les courts circuits avec version analogique (durée de court circuit: illimitée). J4 et J5 sont équipés avec 6/8/10 ou 12 broches Molex 5557. Les versions avec électronique CAN ou PWM sont équipées avec un connecteur AMP 040 Multi-Lock 8 broches. Forces sur demande.  
 La capacité de charge statique possible (max. 190 mm éloigné du point de rotation) est de 2000 N sur les axes x et y, de 700 N sur l'axe z. 8 x 10<sup>6</sup> opérations correspondent 2 x 10<sup>6</sup> cycle de elobau.

Kabelsätze siehe S. 131 (L2.D001A)  
 Cable sets see p. 131 (L2.D001A)  
 Câbles associés voir p. 131 (L2.D001A)

Änderungen und Irrtümer bleiben vorbehalten. Abbildungen ähnlich. Maßgeblich sind die dem ausgelieferten Produkt beigelegten technischen Dokumentationen. The relevant corresponding technical documents will be supplied with the product. Certain product descriptions can be similar therefore please ensure that you have the latest version of documentation for your specific product prior to any use. elobau reserves the right to change technical data and documentation without notice. Sous réserve de modifications et d'erreurs. Images similaires. Les documentations techniques accompagnant les produits sont d'application.



Wir produzieren klimaneutral.  
 We produce in a carbon-neutral manner.  
 Nous produisons avec un bilan carbone neutre.

# Joystickbasis und Joystickgriffe

## Joystick base and Joystick handle

### Joystick et poignée

**J4 .....**/  
**J5 .....**

**Robustjoystickbasis**  
**Heavy duty joystick base**  
**Joystick robuste**

J4 Joystick mit Multifunktionsgriff 341G...  
J4 joystick with multi function lever 341G...  
J4 joystick avec pommeau multifonctions 341G...

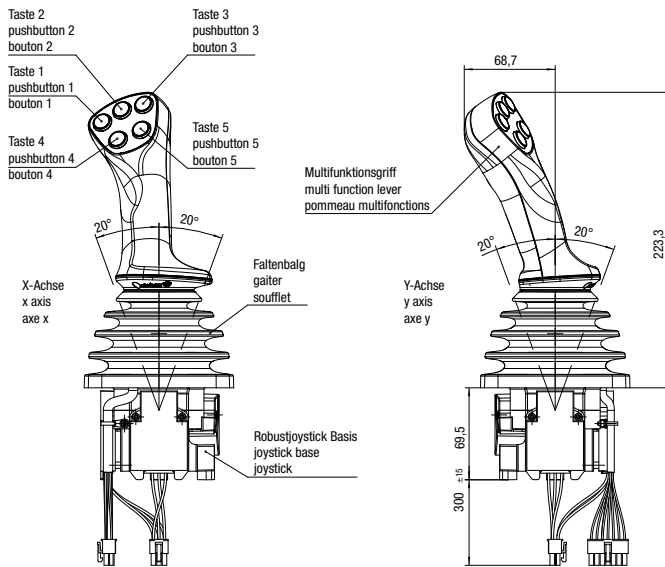

J4 Joystick mit Multifunktionsgriff 361G...  
J4 joystick with multi function lever 361G...  
J4 joystick avec pommeau multifonctions 361G...

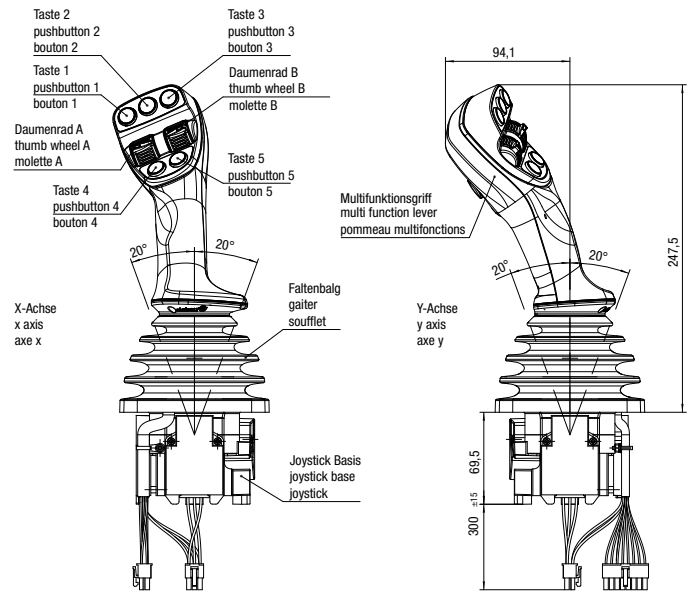

J5 Joystick mit Multifunktionsgriff 341G...  
J5 joystick with multi function lever 341G...  
J5 joystick avec pommeau multifonctions 341G...

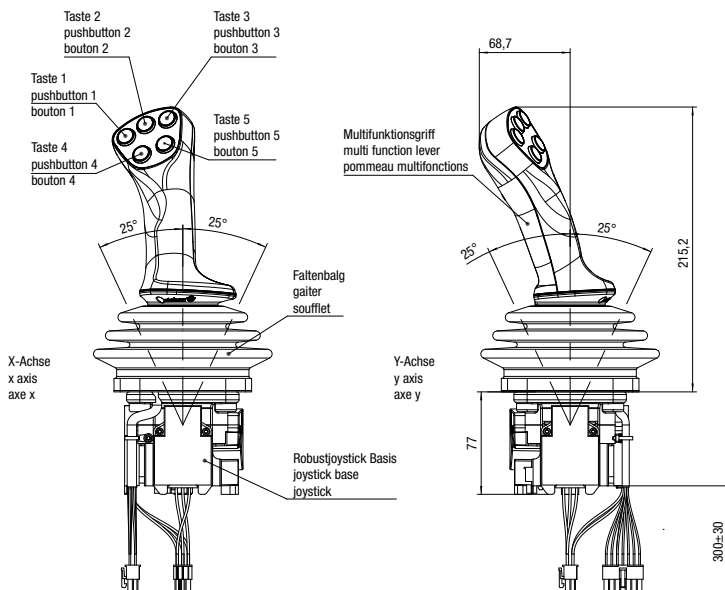

J5 Joystick mit Multifunktionsgriff 361G...  
J5 joystick with multi function lever 361G...  
J5 joystick avec pommeau multifonctions 361G...

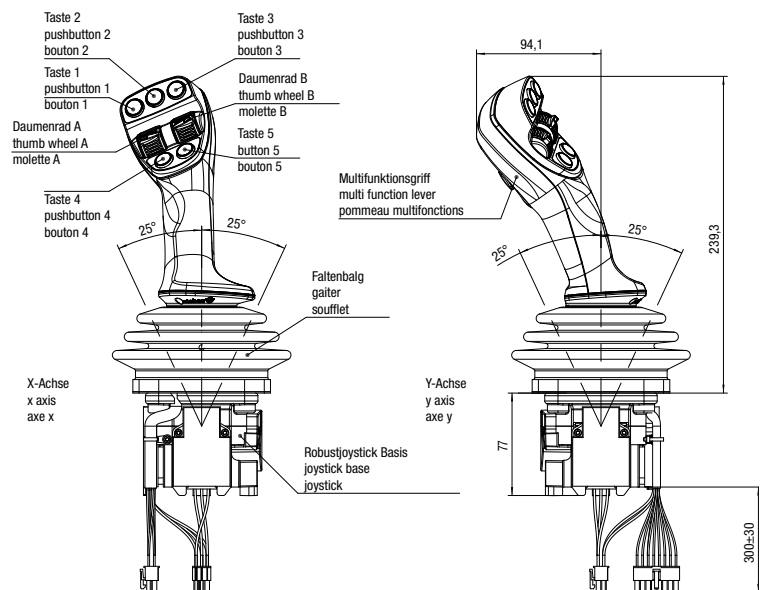

Kabelsätze siehe S. 131 (L2.D001A)  
Cable sets see p. 131 (L2.D001A)  
Câbles associés voir p. 131 (L2.D001A)

# Joystickbasis und Joystickgriffe

## Joystick base and Joystick handle

### Joystick et poignée

**J4 .....** / **Robustjoystickbasis**  
**J5 .....** **Heavy duty joystick base**  
**Joystick robuste**

Schaltausgang jeweils X- und Y-Achse  
 discrete output each X- and Y-axis  
 sortie TOR axes X et Y

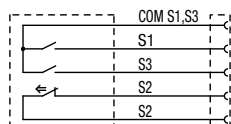

← Darstellung in Mittelstellung (S2 betätigt)  
 shown with knob in centre position (S2 operated)  
 état des contacts en position milieu

Analog jeweils X- und Y-Achse  
 analogue each X- and Y-axis  
 analogique axes X et Y

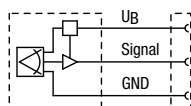

Halbredundant jeweils X- und Y-Achse  
 semi-redundant each X- and Y-axis  
 semi-redondant axes X et Y

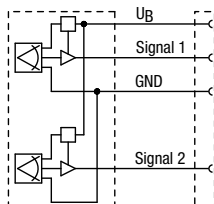

Nach Kundenspezifikation  
 According to customer specification  
 Selon spécification du client

Redundant jeweils X- und Y-Achse  
 redundant each X- and Y-axis  
 redondant axes X et Y

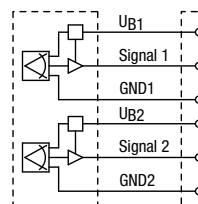

Nach Kundenspezifikation  
 According to customer specification  
 Selon spécification du client

CAN

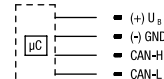

Nach Kundenspezifikation  
 According to customer specification  
 Selon spécification du client

analog analogue analogique	Typen Nr. type no. référence	Betriebsspannung operating voltage tension d'alim.	Ausgangssignal output signal signal de sortie	Stromaufnahme current consumption consommation de courant	Lastwiderstand load resistance résistance de charge	Mittelstellung centre position zéro
	J4 A1.....	10–30 V DC	4–20 mA	bei 12 V max. 18 mA	10 V < 250 Ω 30 V < 1250 Ω	12 mA
	J4 A6.....	4,5–5,5 V DC	0,5–4,5 V DC ratiom./propor.	max. 15 mA	> 20 kΩ	typ. 2,5 V
	J4 A7.....	10–30 V DC	0,5–4,5 V DC	bei 12 V max. 15 mA	> 20 kΩ	typ. 2,5 V
	J5 A1.....	10–30 V DC	4–20 mA	bei 12 V max. 18 mA	10 V < 250 Ω 30 V < 1250 Ω	12 mA
	J5 A6.....	4,5–5,5 V DC	0,5–4,5 V DC ratiom./propor.	max. 15 mA	> 20 kΩ	typ. 2,5 V
	J5 A7.....	10–30 V DC	0,5–4,5 V DC	bei 12 V max. 15 mA	> 20 kΩ	typ. 2,5 V

Schaltausgang discrete output sortie TOR	Typen Nr. type no. référence	Schaltspannung switching voltage tension de commutation	Schaltstrom switching current courant de commutation	Schaltleistung switching power pouvoir de coupure	Kontaktart contact form forme de contact
	J4 D8..... J5 D8.....	max. 48 V	max. 0,3 A	max. 10 W / 10 VA	3 x Schließer / 3 x N.O. / 3 x NO

Typen Nr. type no. référence	CAN-Bus und PWM-Signale CAN-Bus and PWM signals réseau CAN et signaux PWM	Verpolschutz reverse connection protected protégé contre les inversions de polarité	Temperaturbereich temperature range plage de température	Schutzart protection class protection
J4 .....	nach Kundenspezifikation according to customer specification à spécifier	ja/yes/oui	-25...+85°C mit Taste/with push button switches/avec boutons	Elektronik/electronics/ électronique IP67
J5 .....			-40...+85°C ohne Taste/wit- hout push button switches/ sans boutons	

Kabelsätze siehe S. 131 (L2.D001A)  
 Cable sets see p. 131 (L2.D001A)  
 Câbles associés voir p. 131 (L2.D001A)

Änderungen und Irrtümer bleiben vorbehalten. Abbildungen ähnlich. Maßgeblich sind die dem ausgelieferten Produkt beigelegten technischen Dokumentationen.  
 The relevant corresponding technical documents will be supplied with the product. Certain product descriptions can be similar therefore please ensure that you have the latest version of documentation for your specific product prior to any use. elobau reserves the right to change technical data and documentation without notice.  
 Sous réserve de modifications et d'erreurs. Images similaires. Les documentations techniques accompagnant les produits sont d'application.



Wir produzieren klimaneutral.  
 We produce in a carbon-neutral manner.  
 Nous produisons avec un bilan carbone neutre.

# Joystickbasis und Joystickgriffe

## Joystick base and Joystick handle

### Joystick et poignée

**J4 .....** / **Robustjoystickbasis**  
**J5 .....** **Heavy duty joystick base**  
**Joystick robuste**

<p>1) Joystick mit montiertem Multifunktionsgriff Joystick with multifunctional lever mounted Joystick avec pommeau multifonctions monté</p> <p>2) ohne Multifunktionsgriff without multifunctional lever sans pommeau multifonctions</p>	<p>1) Joystick mit montiertem Multifunktionsgriff Joystick with multifunctional lever mounted Joystick avec pommeau multifonctions monté</p> <p>2) ohne Multifunktionsgriff without multifunctional lever sans pommeau multifonctions</p>	<p>1) Joystick mit montiertem Multifunktionsgriff Joystick with multifunctional lever mounted Joystick avec pommeau multifonctions monté</p> <p>2) ohne Multifunktionsgriff without multifunctional lever sans pommeau multifonctions</p>
<p><b>J4 ... AAA. OG ...</b>  <b>J5 ... AAA. OG ...</b></p> <p><b>Griffversion</b> G = Multifunktionsgriff</p> <p><b>Verriegelung</b> 0 = Mittelstellung nicht mechanisch verriegelbar (Mittelstellung mechanisch verriegelbar auf Anfrage)</p> <p><b>Betätigung</b> 0 = multiaxial 1 = Nord, Süd, West, Ost – zwingend bei Schaltausgang Ausführung 2 = einachsige*</p> <p><b>Endstellungen</b> A = tastend</p> <p><b>EMV-Festigkeit</b> A = Kfz-Bereich (DIN 40839; Prüfimpuls 1, 2, 3a/b; Feldeinstreuung 200 V/m)</p> <p><b>Ausgangssignal analog</b> 1 = 4–20 mA DC 6 = 0,5–4,5 V DC ratiometrisch 7 = 0,5–4,5 V DC Schaltausgang 8 = 3 Schaltpunkte je Achse</p> <p><b>Elektronik</b> A = analog C = CAN-Bus-fähig D = Schaltausgang R = analog redundant</p>	<p><b>handle</b> G = multifunction handle</p> <p><b>locking</b> 0 = centre position without mechanical shaft lock (centre position with mechanical shaft lock on request)</p> <p><b>actuation</b> 0 = multi-axial 1 = north, south, west, east actuation mandatory with the discrete output version 2 = with one axis*</p> <p><b>end positions</b> A = no detent</p> <p><b>EMC standards</b> A = automobile industry (DIN 40839; testing impulses 1, 2, 3a/b; interference withstand 200 V/m)</p> <p><b>output signal analogue</b> 1 = 4–20 mA DC 6 = 0,5–4,5 V DC ratiometric 7 = 0,5–4,5 V DC discrete output 8 = 3 switching points per axis</p> <p><b>electronics</b> A = analogue C = conn. to CAN-Bus D = discrete output R = analogue with redundancy</p>	<p><b>levier</b> G = pommeau multifonctions</p> <p><b>verrouillage</b> 0 = position milieu sans verrouillage du levier (position milieu avec verrouillage du levier sur demande)</p> <p><b>levier (mouvements)</b> 0 = se déplace dans toutes les directions 1 = se déplace en croix – impératif avec version sortie TOR 2 = se déplace dans sur une seule axe</p> <p><b>positions extrêmes</b> A = sans maintien</p> <p><b>Directives CEM</b> A = l'industrie automobile (DIN 40839; impulsion de test 1, 2, 3a/b; immunité aux interférences 200 V/m)</p> <p><b>signal de sortie analogique</b> 1 = 4–20 mA DC 6 = 0,5–4,5 V DC ratiométrique 7 = 0,5–4,5 V DC sortie TOR 8 = 3 points de commutation par axe</p> <p><b>type</b> A = analogique C = compatible réseau CAN D = sortie TOR R = analogique redundant</p>

\* Achtung: bei einachsiger Ausführung entfällt bei der Typennummer eine Stelle (s. untenstehendes Bestellbeispiel).  
Please note: when only one axis is required the type number has only 9 digits (like shown below in the ordering example).  
Attention: dans ce cas la référence du produit comporte 9 chiffres au lieu de 10 (voir exemple ci-dessous).

#### Bestellbeispiel

Joystick J 4, Schaltausgang, Ausgangssignal analog 0,5–4,5 V DC ratiometrisch, EMV 200 V/m, IEC 801-3, Endstellungen tastend (x- u. y-Achse), multiaxiale Betätigung, mit Multifunktionsgriff vom Typ 2 mit 3 Tasten, 2 LED und Fingertaste:

- 1) J 4 A 6 A A A 0 0 G 2 3 2 T ohne Multifunktionsgriff:
- 2) einachsige: J 4 A 6 A A 2 0
- zweiachsige: J 4 A 6 A A A 0 0

#### ordering example

Joystick J 4, discrete output, output signal analogue 0,5–4,5 V DC ratiometric, EMC 200 V/m, IEC 801-3, end position with no detent (x- and y-axis), multi-axial actuation, with multi function lever type 2 with 3 buttons, 2 LED and activation button:

- 1) J 4 A 6 A A A 0 0 G 2 3 2 T without multi function lever:
- 2) 1 axis: J 4 A 6 A A 2 0
- 2 axis: J 4 A 6 A A A 0 0

#### exemple de commande

Joystick J 4, sortie TOR, signal de sortie analogique 0,5–4,5 V DC ratiométrique, CEM 200 V/m, IEC 801-3, positions extrêmes sans maintien (axe x et y), mouvements dans toutes les directions, avec levier fonction multiples type 2 avec 3 boutons, 2 LED et bouton d'activation :

- 1) J 4 A 6 A A A 0 0 G 2 3 2 T sans levier fonction multiples:
- 2) 1 axe: J 4 A 6 A A 2 0
- 2 axe: J 4 A 6 A A A 0 0

Kabelsätze siehe S. 131 (L2.D001A) / Cable sets see p. 131 (L2.D001A) / Câbles associés voir p. 131 (L2.D001A)

# Joystickbasis und Joystickgriffe

## Joystick base and Joystick handle

### Joystick et poignée

### 351CM...

CAN-Elektronikmodul  
CAN electronic module  
Module électronique CAN

CAN

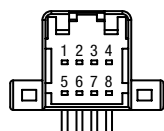
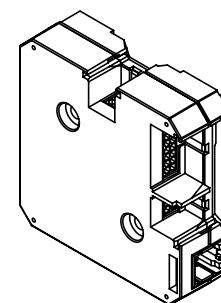
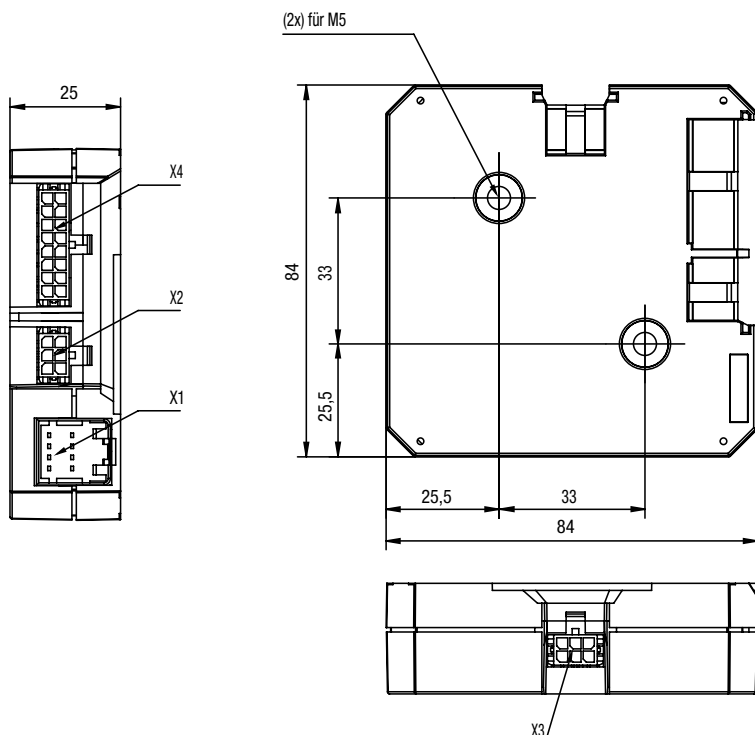

X1

- 1 +24VDC
- 2 +24VDC
- 3 GND
- 4 GND
- 5 CAN\_H
- 6 CAN\_L
- 7 CAN\_L
- 8 CAN\_H



X2

- 1 XA\_+5VDC
- 2 XA\_AI1
- 3 XA\_GND
- 4 -
- 5 XA\_AI2
- 6 -



X3

- 1 YA\_+5VDC
- 2 YA\_AI1
- 3 YA\_GND
- 4 -
- 5 YA\_AI2
- 6 -



X4

- 1 K\_AI1
- 2 K\_AI2
- 3 K\_AI3
- 4 K\_AI4
- 5 K\_AI5
- 6 K\_AI6
- 7 K\_AI7
- 8 K\_AI8
- 9 K\_AI9
- 10 K\_AI10
- 11 K\_LED1
- 12 K\_LED2
- 13 K\_LED3
- 14 K\_LED4
- 15 K\_GND
- 16 K\_+5VDC

CAN-Elektronikmodul für J4 und J5 (J6 und andere Anwendung auf Anfrage)  
CAN electronic module for J4 and J5 (J6 and other applications on request)  
Module électronique CAN pour J4 et J5 (J6 et autres utilisations sur demande)

Kabelsätze siehe S. 131 (L2.D001A)  
Cable sets see p. 131 (L2.D001A)  
Câbles associés voir p. 131 (L2.D001A)

Typen Nr. type no. référence	Betriebsspannung operating voltage tension d'alim.	Stromaufnahme current consumption consommation de courant	Eingangssignal input signal signaux d'entrée	LED Ausgänge LED outputs sortie de la LED	Temperaturbereich temperature range plage de température
351 CM 004 C00	+9 ... +32 VDC	max. 120 mA	0-5 V DC	NPN; internal resistance = 330 Ohm	-25°C ... +85°C
351 CM 004 J00					

Typen Nr. type no. référence	CAN CAN CAN	Protokoll protocol protocole	Abschlusswiderstand terminating resistor résistance de charge	Baudrate baudrate taux de transmission	Sendezyklus cycle time temps de cycle
351 CM 004 C00	ISO 11898, CAN specification 2.0B	CANopen	Nein / no / non	250 kbit/s	20 ms
351 CM 004 J00		SAE J1939			100 ms

# Joystickbasis und Joystickgriffe

## Joystick base and Joystick handle

### Joystick et poignée

351 CM 006C00

CAN-Adapter

CAN

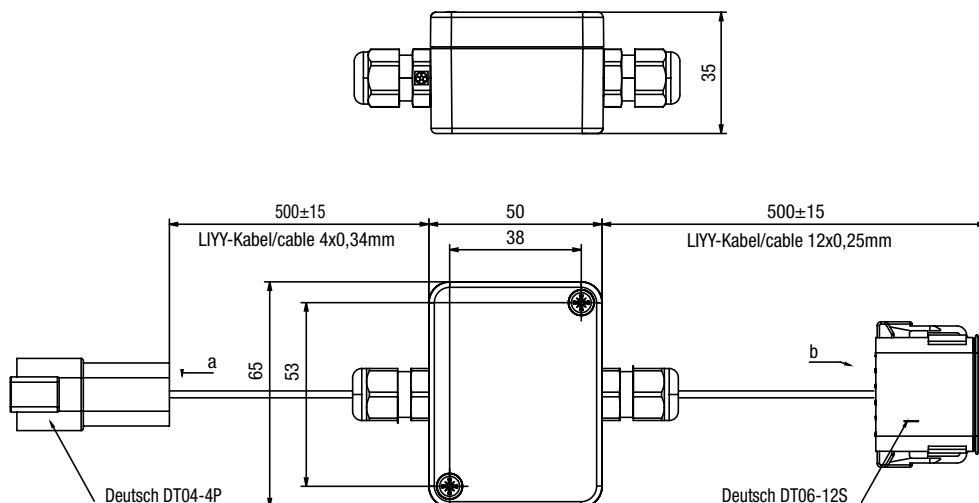

a



1 0V  
2 Ub  
3 CAN-H  
4 CAN-L

b

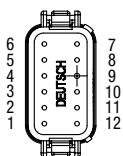

1 IN-1  
2 IN-2  
3 IN-3  
4 IN-4  
5 IN-5  
6 IN-6  
7 IN-7  
8 IN-8  
9 IN-9  
10 IN-10  
11 GNDE  
12 +5V

Typen Nr. type no. référence	Betriebsspannung operating voltage tension d'alim.	Betriebsstrom operating current courant d'alimentation	Schutzart protection class protection	Temperaturbereich temperature range plage de température	Eingangssignal input signal signaux d'entrée
351 CM 006C00	+9 ... +32 VDC	max. 100 mA	Elektronik/electronics/ électronique IP65	-25°C ... +85°C	0-5 V DC

Typen Nr. type no. référence	CAN CAN CAN	Protokoll protocol protocole	Abschlusswiderstand terminating resistor résistance de charge	Baudrate baudrate taux de transmission	Knotennummer Node-ID ID noeud	Sendezyklus cycle time temps de cycle
351 CM 006C00	ISO 11898, CAN specification 2.0B	CANopen	Nein / no / non	250 kbit/s	0x11	20 ms



# Joystickbasis und Joystickgriffe

## Joystick base and Joystick handle

### Joystick et poignée

**351 G....** Multifunktionsgriff  
Multi function lever  
Pommeau multifonctions

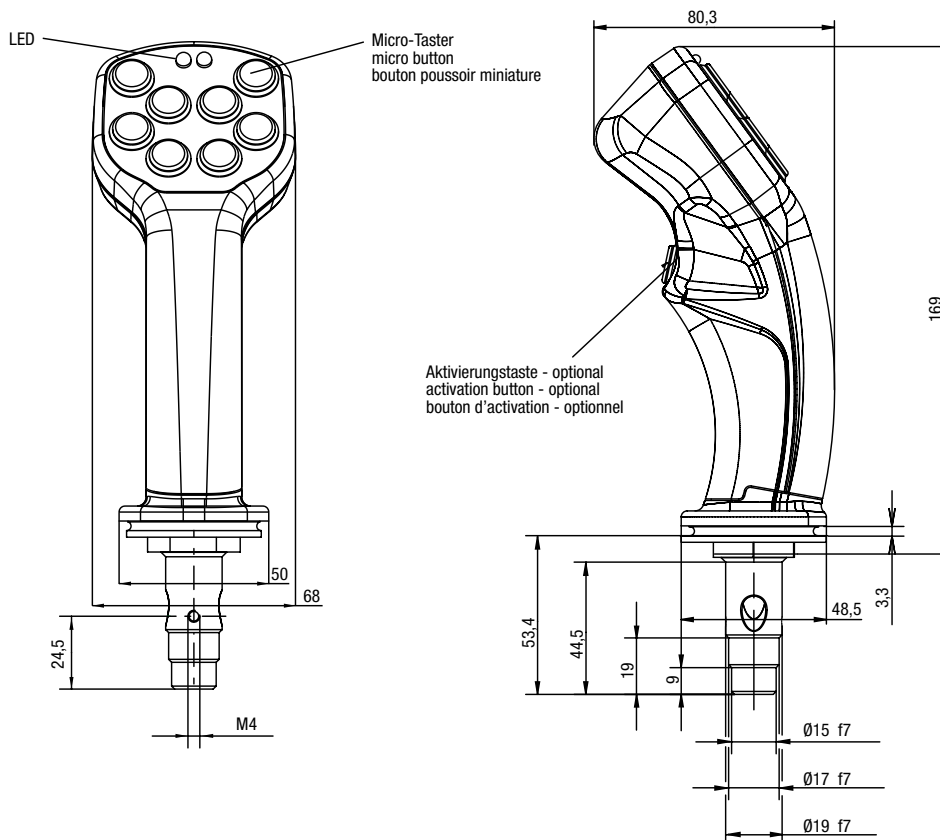

spezifische Bezeichnungsfolien auf Anfrage  
specific labels on request  
étiquettes spécifiques sur demande



**Typ 1**  
max. 8 Tasten möglich  
max. 2 LED möglich

**type 1**  
max. 8 push buttons possible  
max. 2 LED possible

**type 1**  
maxi. 8 boutons possibles  
maxi. 2 LED possibles



**Typ 4**  
max. 5 Tasten möglich  
max. 2 LED möglich

**type 4**  
max. 5 push buttons possible  
max. 2 LED possible

**type 4**  
maxi. 5 boutons possibles  
maxi. 2 LED possibles



**Typ 5**  
max. 2 Tasten möglich  
max. 2 LED möglich

**type 5**  
max. 2 push buttons possible  
max. 2 LED possible

**type 5**  
maxi. 2 boutons possibles  
maxi. 2 LED possibles

Typen Nr. type no. référence	Schaltspannung switching voltage tension de commut.	Schaltstrom switching current courant de commut.	Schalteleistung switching power pouvoir de coupure	Kontaktart contact form forme de contact	Tastenhub button stroke course du bouton
145 MT .....	max. 48 V	max. 0,5 A	max. 10 W / 10 VA	Schließer / N.O. / NO	2,5 mm

**351 G....**      **Multifunktionsgriff**  
**Multi function lever**  
**Pommeau multifonctions**

**351 G . . . .**

<p><b>Griffversion</b>  T = Aktivierungstaste  Ohne Taste*</p> <p><b>Anzahl LED</b>  0 = keine  1 = eine  2 = zwei</p> <p><b>Anzahl Tasten</b>  0 = keine    3 = drei    6 = sechs  1 = eine    4 = vier    7 = sieben  2 = zwei    5 = fünf    8 = acht</p> <p><b>Typ</b>  1 = Tasten, (LED)  4 = ein Daumenrad, links, (Tasten), (LED)  5 = zwei Daumenräder, (Tasten), (LED)</p>	<p><b>lever</b>  T = activation button  Without button*</p> <p><b>number of LED</b>  0 = none  1 = one  2 = two</p> <p><b>number of buttons</b>  0 = zero    3 = three    6 = six  1 = one    4 = four    7 = seven  2 = two    5 = five    8 = eight</p> <p><b>type</b>  1 = buttons, (LED)  4 = one thumbwheel pot, left, (buttons), (LED)  5 = two thumbwheel pots, (buttons), (LED)</p>	<p><b>levier</b>  T = bouton d'activation  Sans bouton*</p> <p><b>nombre de LED</b>  0 = aucune  1 = une  2 = deux</p> <p><b>nombre de bouton</b>  0 = aucun    3 = trois    6 = six  1 = un    4 = quatre    7 = sept  2 = deux    5 = cinq    8 = huit</p> <p><b>type</b>  1 = boutons, (LED)  4 = une mollette potentiom., (boutons), (LED)  5 = deux mollettes potentiom, (boutons), (LED)</p>
---	---	--

\* Achtung: Bei Griffversion „Ohne Taste“ entfällt bei der Typennummer die letzte Stelle  
Please note: With lever „Without button“ the type number has only 7 digits  
Attention: Avec levier „Sans bouton“ la référence du produit comporte 7 chiffres au lieu de 8

**Bestellbeispiel**

Multifunktionsgriff Typ 1 mit  
Aktivierungstaste: **3 5 1 G 1 6 0 T**  
Multifunktionsgriff Typ 1 ohne  
Aktivierungstaste: **3 5 1 G 1 6 0**

Bitte geben Sie bei der Bestellung die  
gewünschte Lage der Tasten sowie  
deren Kappenfarbe an.

**ordering example**

Type 1 with activation button:  
**3 5 1 G 1 6 0 T**  
Type 1 without activation button:  
**3 5 1 G 1 6 0**

Please specify position and colour of the  
buttons, when ordering.

**exemple de commande**

Type 1 avec bouton d'activation:  
**3 5 1 G 1 6 0 T**  
Type 1 sans bouton d'activation:  
**3 5 1 G 1 6 0**

Lors de votre commande, veuillez indiquer  
la position souhaitée des boutons ainsi que  
leurs couleurs.

# Joystickbasis und Joystickgriffe

## Joystick base and Joystick handle

### Joystick et poignée

341 G.... /  
342 G....

Multifunktionsgriff  
Multi function lever  
Pommeau multifonctions

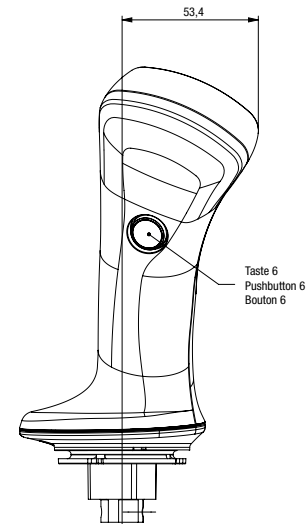
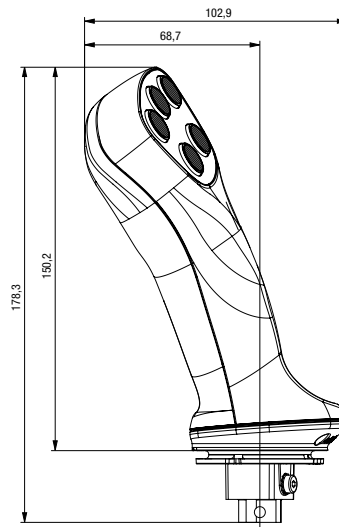
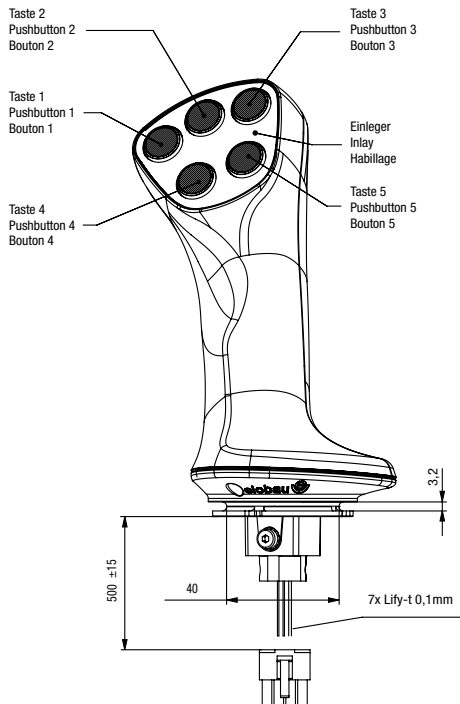

**Typ 1**  
max. 6 Tasten mit Nacht- und Funktionsbeleuchtung möglich

**type 1**  
max. 6 push buttons with night and function illumination possible

**type 1**  
maxi. 6 boutons avec éclairage de nuit et de fonction possibles  
maxi. 2 LED possibles

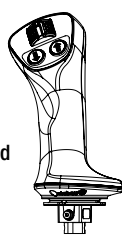

**Typ 2**  
max. 3 Tasten mit Nacht- und Funktionsbeleuchtung möglich  
max. 1 Daumenrad mit Beleuchtung

**type 2**  
max. 3 push buttons with night and function illumination possible  
max. 1 illuminated Thumbwheel possible

**type 2**  
maxi. 3 boutons avec éclairage de nuit et de fonction possibles  
maxi. 1 molette éclairée possible



**Typ 3**  
max. 3 Tasten mit Nacht- und Funktionsbeleuchtung möglich  
max. 1 Daumenrad mit Beleuchtung

**type 3**  
max. 3 push buttons with night and function illumination possible  
max. 1 illuminated Thumbwheel possible

**type 3**  
maxi. 3 boutons avec éclairage de nuit et de fonction possibles  
maxi. 1 molette éclairée possible

### Montageadapter shaft interfaces Adaptateurs

Griffachse  
Innengewinde M12  
Interface M12 internal  
axe de poignée avec  
taradage M12

Griffachse  
Aussengewinde M12  
Interface M12 external  
axe de poignée filetage  
M12

Griffachse  
Aussengewinde M14x1,5  
Interface M14x1,5 external  
axe de poignée filetage  
M14x1,5

Griffachse  
J4/J5 Anschluss (Links)  
Interface for J4/J5 Joystick (left)  
adaptateur poignée gauche  
sur J4/J5

Griffachse  
J4/J5 Anschluss (rechts)  
Interface for J4/J5 joystick (right)  
adaptateur poignée droite  
sur J4/J5

Griffachse  
J6 Anschluss (links)  
Interface for J6 joystick (right)  
adaptateur poignée gauche  
sur J6

Griffachse  
J6 Anschluss (rechts)  
Interface for J6 joystick (right)  
adaptateur poignée droite  
sur J6

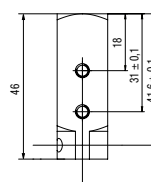
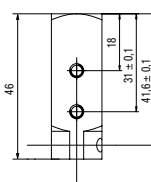
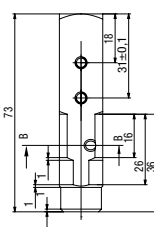
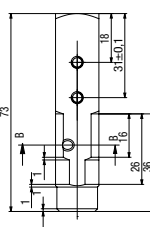
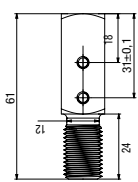
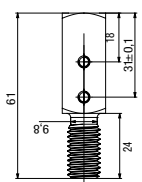
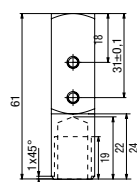

**341 G.... /** Multifunktionsgriff  
**342 G....** Multi function lever  
 Pommeau multifonctions

**341GC ... Griff rechte Hand / right handle / poignée droite**

**342GD ... Griff linke Hand / left handle / poignée gauche**

 Zählnummern  
 (wird von elobau vergeben)      counting numbers  
 (issued by elobau)      numéros d'article  
 (complété par elobau)

**Konfigurierbar über Online Konfigurator**  
**Configurable by online configurator**  
**Configurable par configurateur en ligne**

**Daten Multifunktionsgriff / data multi function lever / données de pommeau multifonctions**

Typen Nr. type no. référence	Temperaturbereich temperature range plage de température	Lagertemperatur storage temperature dépôt température	Gewicht weight poids
341 G....	-25°...+85 °C	-40°...+85 °C	ca. 300 g
342 G....			

**Daten Nanotaste / data nano push button switches / données de nano boutons poussoirs**

Typen Nr. type no. référence	Schaltspannung switching voltage tension de commut.	Schaltstrom switching current courant de commut.	Schaltleistung switching power pouvoir de coupure	LED LED affichage	Kontaktart contact form type de contact
145 NTG .....	max. 48 V	max. 0,3 A	max. 5 W / 5 VA	je nach Vorwiderstand depending on series resistor dependant de résistance de série	Schließer/N.O./NO

**Daten Daumenrad / data thumbwheel / molette éclairée**

Typen Nr. type no. référence	Betriebsspannung operating voltage tension d'alimentation	Betriebsstrom operating current courant d'alimentation	Ausgangsspannung output voltage tension de sortie	Neutralstellung neutral position zéro
175 DT ...	4,5–5,5 V DC	max. 15 mA	0,5–4,5 VDC ratiom./prop. 3 x NPN Schaltausgang/discrete output/sortie TOR	2,5 V DC

# Joystickbasis und Joystickgriffe

## Joystick base and Joystick handle

### Joystick et poignée

361 G... /  
362 G...

Multifunktionsgriff  
Multi function lever  
Pommeau multifonctions

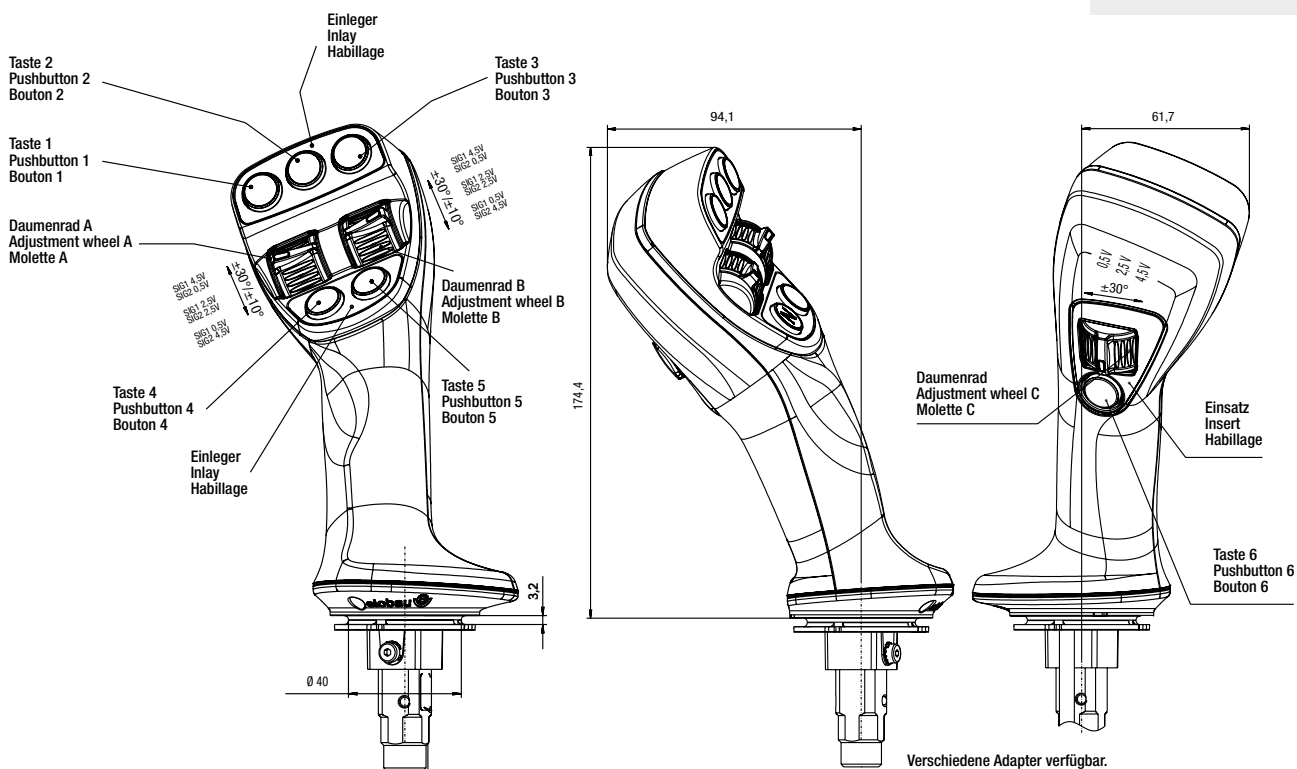

### Montageadapter shaft interfaces Adaptateurs

Griffachse  
Innengewinde M12  
Interface M12 internal  
axe de poignée avec  
taradage M12

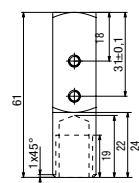

Griffachse  
Aussengewinde M12  
Interface M12 external  
axe de poignée filetage  
M12

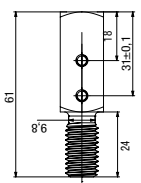

Griffachse  
Aussengewinde M14x1,5  
Interface M14x1,5 external  
axe de poignée filetage  
M14x1,5

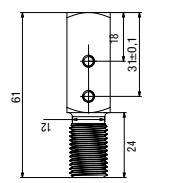

Griffachse  
J4/J5 Anschluss (links)  
Interface for J4/J5 Joystick (left)  
adaptateur poignée gauche  
sur J4/J5

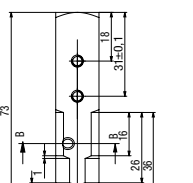

Griffachse  
J4/J5 Anschluss (rechts)  
Interface for J4/J5 joystick (right)  
adaptateur poignée droite  
sur J4/J5

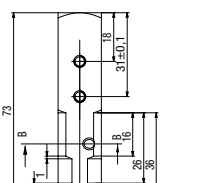

Griffachse  
J6 Anschluss (links)  
Interface for J6 joystick (right)  
adaptateur poignée gauche  
sur J6

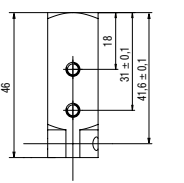

Griffachse  
J6 Anschluss (rechts)  
Interface for J6 joystick (right)  
adaptateur poignée droite  
sur J6

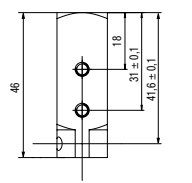

Der Multifunktionsgriff 361G.. bietet die maximale Flexibilität, um einen Standardgriff an ein spezifisches Kabinendesign anzupassen. Farblich sind die Griffschalen, der Bedienkopf und die rückseitige Bedieneinheit an Ihre Bedürfnisse anpassbar. Mit bis zu drei Daumenrädern und bis zu 7 Tastenpositionen, bietet der Griff eine Vielzahl an zusätzlichen Steuerungsfunktionen.

The multi function lever 361G.. provides maximum flexibility for adapting a standard lever to a specific cab design. The colours of the lever plates, the control handle and the control unit at the rear can be adapted to your needs. With up to three thumbwheels and as many as 7 pushbutton positions, the lever offers a wide variety of additional control functions.

La poignée multifonctions 361G.. offre une flexibilité maximale pour adapter une poignée standard à un design de cabine spécifique. Il est possible d'adapter à vos besoins la couleur des coques de la poignée, des boutons et molettes, des habillages avant et arrière. Avec ses trois molettes et jusqu'à 7 boutons, la poignée offre un grand nombre de fonctions supplémentaires.

# Joystickbasis und Joystickgriffe

## Joystick base and Joystick handle

### Joystick et poignée

**361 G.... /** Multifunktionsgriff  
**362 G....** Multi function lever  
 Pommeau multifonction

Folienfarbe wählbar (optional)  
 A variety of membrane  
 colour options  
 Couleur de l'habillage  
 au choix

Kapazitive Anwesenheitserkennung  
 und Elektronik integriert (optional)  
 Integrated capacitive presence  
 detection and electronics (optional)  
 Détection capacitive de présence  
 et électronique intégrées

Verschiedene Faltenbalgversionen  
 und Montageadapter  
 Several versions of rubber gaiters  
 and interface adapters available  
 Différentes versions de soufflets  
 et d'adaptateurs de montage



Nanotaster  
 Nano push button switches  
 Nano boutons poussoirs  
 (siehe Seite/see page/voir page 67)



Daumenrad mit 3-Farbbeleuchtung  
 thumbwheel 3-colour illumination  
 Molette éclairage à 3 couleurs  
 (siehe Seite/see page/voir page 52)

Mit integrierter CAN-  
 Schnittstelle (optional)  
 with integrated CAN-  
 interface (optional)  
 avec interface CAN  
 intégrée (optionnel)



Einbaupositionen für drittes Daumenrad  
 und Taste, oder zwei zusätzliche Tasten  
 rückseitig  
 Installation positions for third thumb-  
 wheel and pushbutton, or two additional  
 pushbuttons on the rear  
 Positions de montage pour une troisième  
 molette et un bouton ou deux boutons en  
 face arrière



Farben und Symbolik  
 wählbar  
 A variety of colour and  
 symbol options  
 Couleurs et symbolique au  
 choix



Vollständig beleuchtet  
 Completely illuminated  
 Entièrement éclairée



Rückseitiges Daumenrad (vertikal/  
 horizontal montiert), oder zwei  
 Tastenpositionen  
 Thumbwheel on rear (mounted  
 vertical/horizontal), or two pushbutton  
 positions  
 Molette sur face arrière (montée à la  
 verticale/horizontale) ou deux boutons



Linke-Hand-Version  
 Left-hand version  
 Version main gauche



Montierbar auf alle gängigen  
 Joysticktypen und hydraulischen  
 Vorsteuergeräten  
 Can be fitted to all common  
 joystick types and hydraulic pilot  
 devices  
 Montable sur tous les types de  
 joysticks usuels et leviers de  
 commandes hydrauliques

# Joystickbasis und Joystickgriffe

## Joystick base and Joystick handle

### Joystick et poignée

**361 G.... / Multifunktionsgriff**  
**362 G.... Multi function lever**  
**Pommeau multifonction**

#### Daten Multifunktionsgriff / data multi function lever / données de pommeau multifonctions

Typen Nr. type no. référence	Temperaturbereich temperature range plage de température	Lagertemperatur storage temperature dépôt température	Gewicht weight poids
361 G....	-25°...+85 °C	-40°...+85 °C	ca. 300 g
362 G....			

#### Daten Nanotaste / data nano push button switches / données de nano boutons poussoirs

Typen Nr. type no. référence	Schaltspannung switching voltage tension de commut.	Schaltstrom switching current courant de commut.	Schaltleistung switching power pouvoir de coupure	LED LED affichage	Kontaktart contact form type de contact
145 NTG .....	max. 48 V	max. 0,3 A	max. 5 W / 5 VA	je nach Vorwiderstand depending on series resistor dependant de résistance de série	Schließer/N.O./NO

#### Daten Daumenrad / data thumbwheel / molette éclairée

Typen Nr. type no. référence	Betriebsspannung operating voltage tension d'alimentation	Betriebsstrom operating current courant d'alimentation	Ausgangsspannung output voltage tension de sortie	Neutralstellung neutral position zéro
175 DT ...	4,5 –5,5 VDC	max. 15 mA	0,5–4,5 VDC ratiom./prop. 3 x NPN Schaltausgang/discrete output/sortie TOR	2,5 V DC

**361GA ... Griff rechte Hand / right handle / poignée droite**

**362GB ... Griff linke Hand / left handle / poignée gauche**



**Zählnummern**  
(wird von elobau vergeben)

**counting numbers**  
(issued by elobau)

**numéros d'article**  
(complété par elobau)

**Konfigurierbar über Online Konfigurator**  
**Configurable by online configurator**  
**Configurable par configurateur en ligne**

# Daumenrad Thumbwheel Molette proportionnelle

151 DT 01

Daumenrad  
Thumbwheel  
Molette proportionnelle

$U_B$   
5 V

IP 67

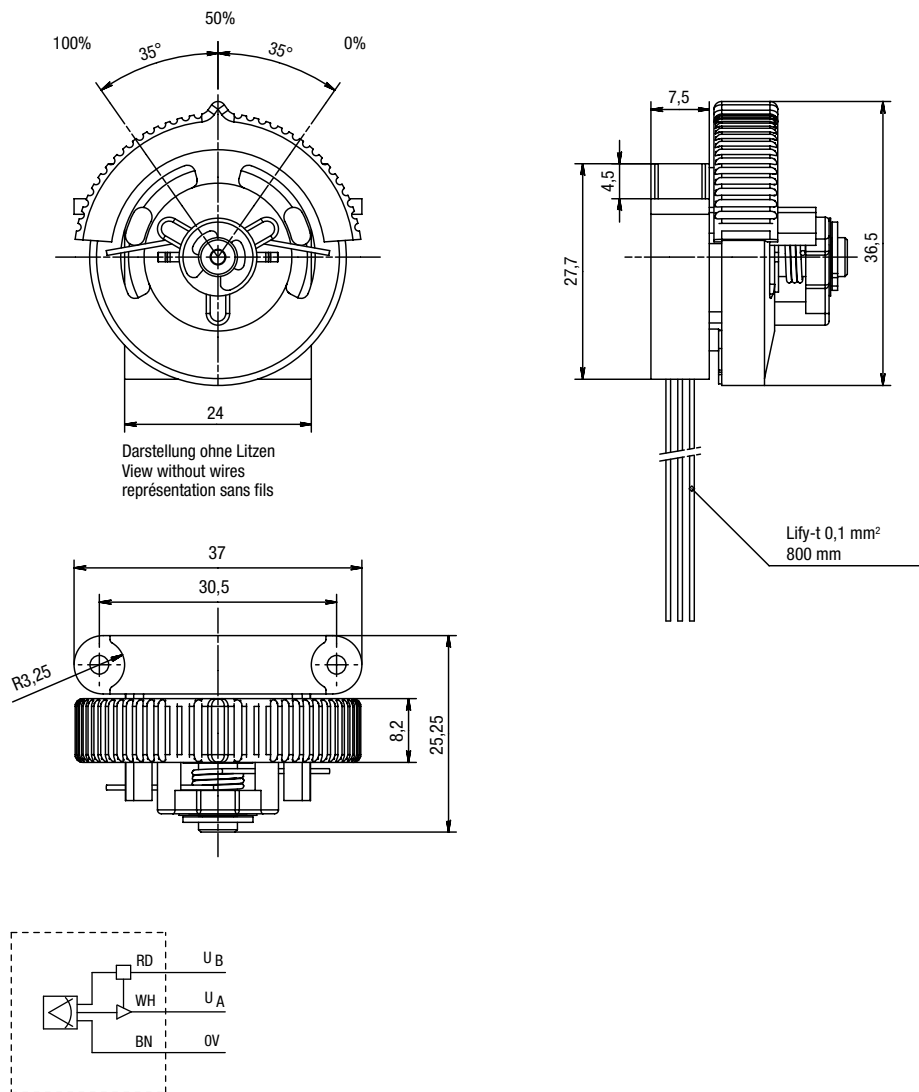

Typen Nr. type no. référence	Betriebsspannung operating voltage tension d'alimentation	Betriebsstrom operating current courant d'alimentation	Ausgangsspannung output voltage tension de sortie	Neutralstellung neutral position zéro
151 DT 01	4,5–5,5 VDC	max. 15 mA	0,5–4,5 VDC ratiom./prop.	2,5 VDC

Typen Nr. type no. référence	Lastwiderstand load resistance résistance de charge	Temperaturbereich temperature range plage de température	Schutzart protection class indice de protection
151 DT 01	> 20 kΩ	-25...+85°C	IP 67 DIN EN 60529



# Beleuchtetes Daumenrad Illuminated thumbwheel Molette éclairée

175 D ...

3-Farbbeleuchtung  
3-colour illumination  
Éclairage à 3 couleurs



tastend / no detent / sans maintien

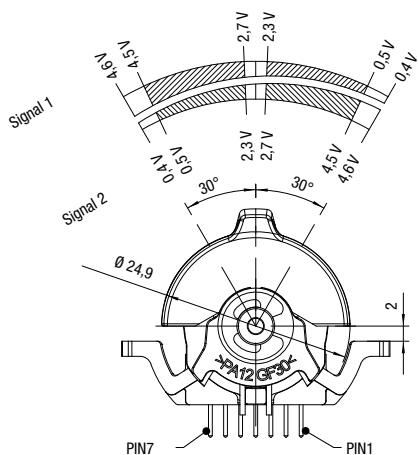

rastend / detent / avec maintien

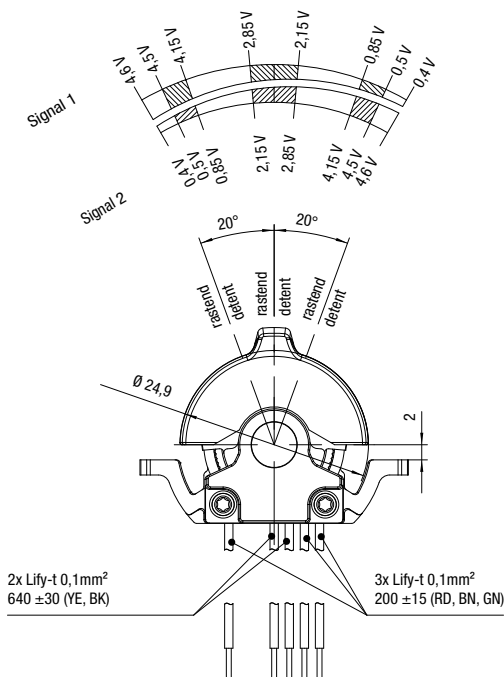

Betätigungskappe Form A  
Actuator form A  
Actionneur forme A

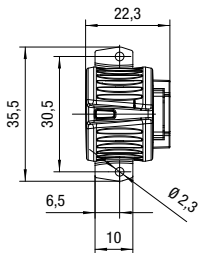
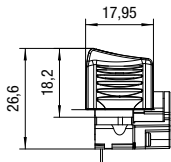

Betätigungskappe Form B  
Actuator form B  
Actionneur forme B

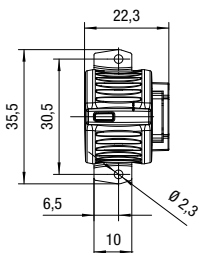
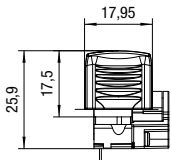

## Beschaltung und Signalverlauf Connection and signal form Câblage et allure du signal

I Ratiometrisch analog  
Ratiometrically analogue  
Ratiométrique analogique

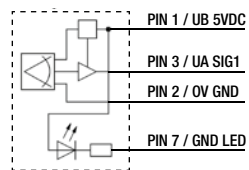

II Halbredundant Analog  
Semi-redundant analog  
Semi-redundant analogique

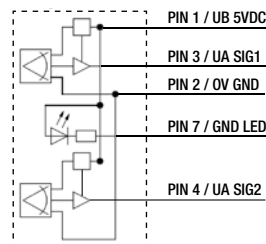

III Redundant Analog  
Redundant analog  
Redondant analogique

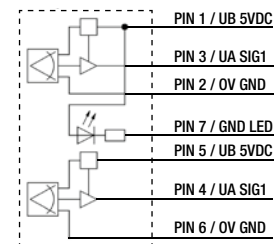

IV Ratiometrisch Analog Multicolour  
Ratiometrically analogue multi-colour  
Ratiométrique analogique multicoloreurs

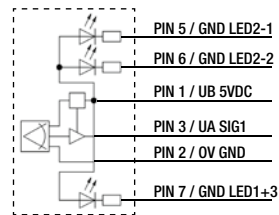

V Halbredundant Analog Multicolour  
Semi-redundant analog multi-colour  
Semi-redundant analogique multicoloreurs

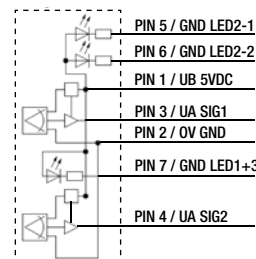

VI Schaltausgang  
Discrete output  
Sortie TOR

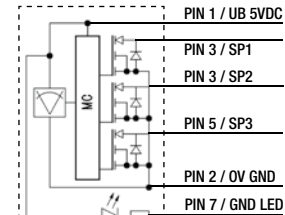

# Beleuchtetes Daumenrad Illuminated thumbwheel Molette éclairée

**175 D ...**      **3-Farbbeleuchtung**  
**3-colour illumination**  
**Éclairage à 3 couleurs**

**Beleuchtung**  
**Illumination**  
**Éclairage**



Die Beleuchtung erfolgt wahlweise über 3 LEDs oder Multicolour-LED für die Mittelstellung. Die Multicolour-LED behält beispielsweise die Beleuchtungsfarbe bei, bis ein Signalpositionswechsel erfolgt.

The illumination is provided optionally via 3 LEDs or a multi-colour LED for the centre position. For example, the multi-colour LED maintains its illuminated colour until a signal position change occurs.

L'éclairage se compose au choix de 3LED ou d'une LED multicolore pour la position centrale. La LED multicolore garde par exemple la même couleur d'éclairage jusqu'à ce qu'un changement de position de signal ait lieu.

**Betätigerfarben**  
**Colours**  
**Couleurs**



**Beleuchtungsfarben LED**  
**Illumination colours LED**  
**Couleurs d'éclairage LED**



Rot, Grün bei Multicolour-LED / Red, green with a multi-colour LED /  
Rouge, vert pour la LED multicolore

Typen Nr. type no. référence	Schaltbild circuit diagram schéma de circuit	Betriebsspannung operating voltage tension d'alimentation	Betriebsstrom operating current courant d'alimentation	Ausgangsspannung output voltage tension de sortie	Neutralstellung neutral position zéro
175 D ...	I – V	4,5–5,5 V DC	max. 15 mA	0,5–4,5 V DC ration./prop.	2,5 V DC

Typen Nr. type no. référence	Schaltbild circuit diagram schéma de circuit	Schaltausgang discrete output sortie TOR	max. Schaltspannung switching voltage max. plage de tension de commut	max. Schaltstrom switching current max. plage de courant de commut	Lastwiderstand load resistance résistance de charge
175 D ...	VI	3 x NPN	24 V DC	100 mA	> 20 kΩ

Typen Nr. type no. référence	Schutzart protection class indice de protection	Anschlussart Conductor Section de raccordement	Einbauöffnung mounting hole trou de montage	Lebensdauer life longévité
175 D ...	Elektronik/electronics/ électronique IP 67	Lify-t 0,1 mm <sup>2</sup> , Molex Mini-Fit Jr.	21,5 x 18,75 mm	> 2 Millionen Schaltspiele > 2 million operating cycles > 2 million cycles

Typen Nr. type no. référence	Betätigung operation Commande	Arbeitstemperaturbereich operating temperature plage de température d'utilisation	Lagertemperaturbereich storage temperature plage de température de stockage	Betätigungswinkel deflection course angulaire
175 DT ...	tastend / no detent / sans maintien	-40°C ... +85°C DIN IEC 68	-40°C ... +85°C DIN IEC 68	± 30° oder/or/ou ±10°
175 DR ...	rastend / detent / avec maintien			±20°

# Beleuchtetes Daumenrad Illuminated thumbwheel Molette éclairée

**175 D ...**      **3-Farbbeleuchtung**  
**3-colour illumination**  
**Éclairage à 3 couleurs**

**175 D . . . . .**

<p>Zählnummer (wird von elobau vergeben)</p> <p>Farbe Betätigungskappe RT = Signalrot SW = Signalschwarz OR = Signalarorange DG = Verkehrsgrau</p> <p>Betätigerform A0 = Form A, ohne LED A1 = Form A, mit LED B0 = Form B, ohne LED B1 = Form B, mit LED</p> <p>LED 0 = ohne LED 1 = mit LED 2 = mit Multicolour-LED (auf Anfrage)</p> <p>Betätigerart R = rastend T = tastend</p>	<p>Counting numbers (issued by elobau)</p> <p>Actuation cap colour RT = Signal red SW = Signal black OR = Signal orange DG = Traffic grey</p> <p>Actuation cap shape A0 = Type A, without LED A1 = Type A, with LED B0 = Type B, without LED B1 = Type B, with LED</p> <p>LED 0 = without LED 1 = with LED 2 = with multi-colour LED</p> <p>Actuation type R = detent T = no detent</p>	<p>Numéros d'article (complété par elobau)</p> <p>Couleur du capuchon de l'actionneur RT = rouge SW = noir OR = orange DG = gris foncée</p> <p>Forme du capuchon de l'actionneur A0 = Forme A, sans LED A1 = Forme A, avec LED B0 = Forme B, sans LED B1 = Forme B, avec LED</p> <p>LED 0 = sans LED 1 = avec LED 2 = avec LED multicolours</p> <p>Type d'actionnement R = avec maintien T = sans maintien</p>
---	---	--

Bitte bei der Bestellung Schaltbild, Betätigungswinkel und Beleuchtungsfarben angeben.  
When ordering, please specify the circuit diagram, the deflection and illuminated colors.  
Veuillez indiquer le schéma de circuit, le course angulaire et la couleur de l'éclairage lors de la commande.



# 4

## Taster Push button switches Boutons poussoirs



mit Super-Seal-Stecker / mit Deutsch-Stecker  
with Super-Seal connector / with Deutsch connector  
avec connecteur Super-Seal / avec connecteur Deutsch

59...61



Microtaster  
Micro push button switches  
Micro boutons poussoirs

62...66



Nanotaster  
Nano push button  
Bouton poussoirs nano

67...69



Microtaster analog  
Analogue micro push button  
Micro bouton poussoirs analogique

70...71



Doppeltaste  
Double push button  
Bouton poussoir double

72



Micro-Wipptaste  
Micro-rocker-switch  
Micro-bouton à bascule

73



PTO-Taster mit Super-Seal-Stecker  
PTO with Super-Seal connector  
Bouton PTO avec connecteur Super-Seal

74



PTO-Taster mit Beleuchtung  
Illuminated PTO  
Bouton PTO éclairée

75





# Taster

## Push button switches

### Boutons poussoirs

## 145 ... A.



**145...AB** mit Super-Seal-Stecker  
with Super-Seal connector  
avec connecteur Super-Seal

**145...AE** mit Deutsch-Stecker  
with Deutsch connector  
avec connecteur Deutsch

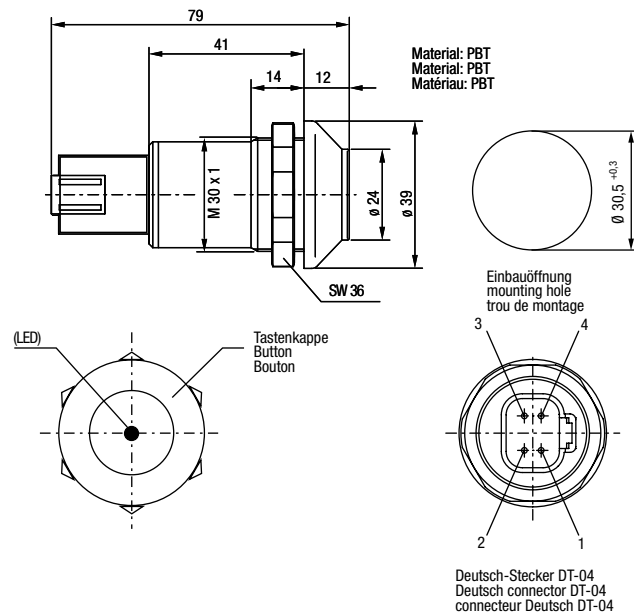
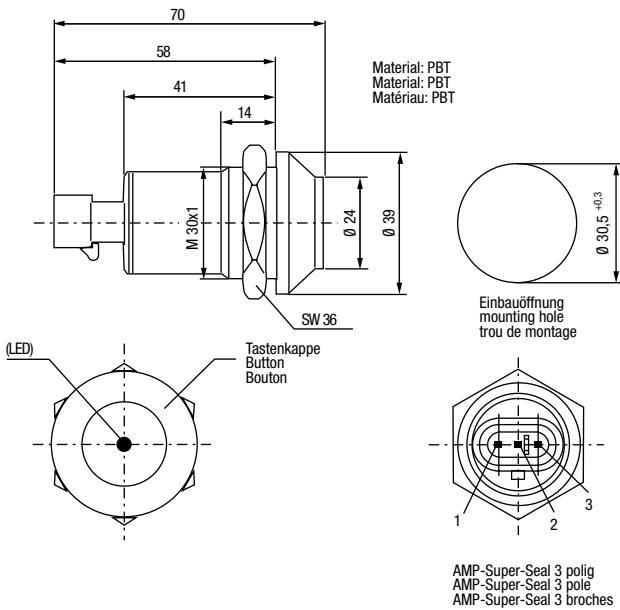

### Betätigerfarben

#### Colours

#### Couleurs

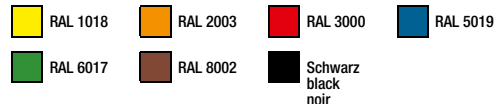

### Beleuchtungsfarben LED

#### Illumination colours LED

#### Couleurs d'éclairage LED

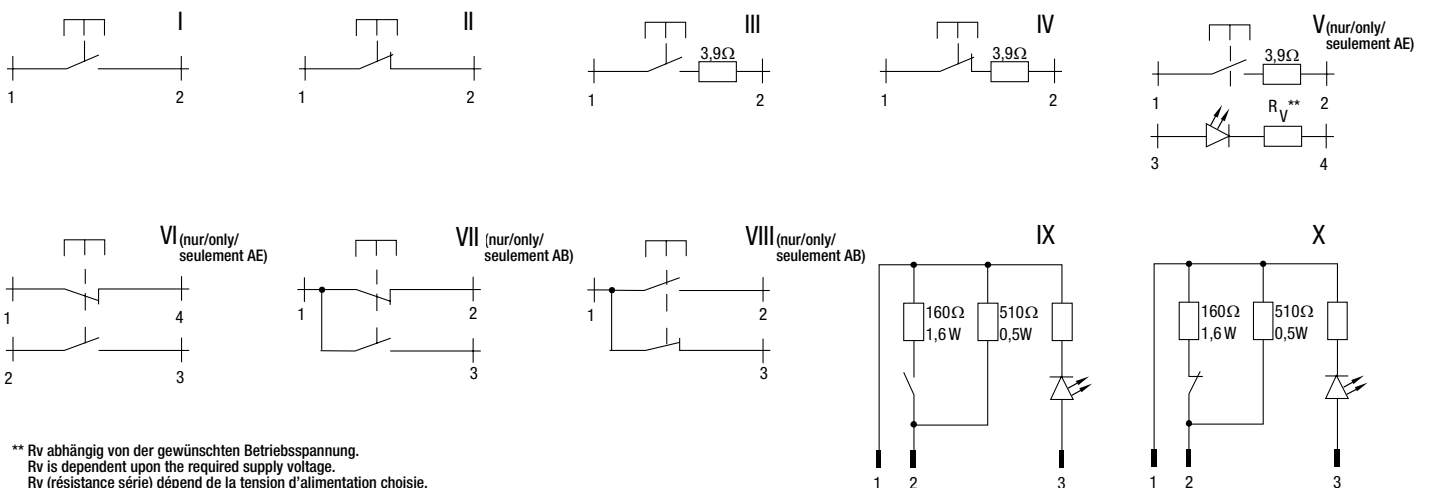

Andere Ausführungen und Schaltspannungen möglich. Bitte fragen Sie an.  
Es besteht die Möglichkeit, die Tastenkappen mit Symbolen zu bedrucken. Bitte geben Sie das gewünschte Symbol mit der Farbe der Tastenkappe bei der Bestellung an.

Other arrangements and switching voltages available on request. Please enquire.  
It is possible to have the button top printed with symbols. Please specify symbol and colour, when ordering.

Contactez-nous pour d'autres réalisations ou caractéristiques.  
Le symbole et la couleur du bouton peuvent être choisis sur mesure. Veuillez spécifier ces caractéristiques lors de la commande.

**145 ... A.**

Typen Nr. type no. référence	Schaltbild circuit diagram schéma de circuit	Schaltspannung switching voltage tension de commut.	Schaltstrom switching current courant de commut.	Schaltleistung switching power pouvoir de coupure	LED LED affichage	Tastenhub button stroke course totale du bouton
145...A.	I	max. 48 V	max. 0,5 A	max. 10 W / 10 VA	nein/no/non	5 mm
	II	max. 48 V	max. 0,5 A	max. 10 W / 10 VA	nein/no/non	
	III	max. 48 V	max. 0,3 A	max. 10 W / 10 VA	nein/no/non	
	IV	max. 48 V	max. 0,3 A	max. 10 W / 10 VA	nein/no/non	
	V (nur/only/ seulement AE)	max. 48 V	max. 0,3 A	max. 10 W / 10 VA	nein/no/non	
	VI (nur/only/ seulement AE)	max. 48 V	max. 0,5 A	max. 10 W / 10 VA	nein/no/non	
	VII (nur/only/ seulement AB)	max. 48 V	max. 0,5 A	max. 10 W / 10 VA	nein/no/non	
	VIII (nur/only/ seulement AB)	max. 48 V	max. 0,5 A	max. 10 W / 10 VA	nein/no/non	
	IX	max. 16 V	max. 0,1 A	–	ja/yes/oui	
	X	max. 16 V	max. 0,1 A	–	ja/yes/oui	

Typen Nr. type no. référence	Schaltbild circuit diagram schéma de circuit	Temperaturbereich temperature range plage de température	Befestigungsart mounting type méthode de fixation	Anzugsdrehmoment tightening torque couple de serrage	Schutzart protection class protection
145...A.	I	-20...+100°C	Mutter SW 36 screw SW 36 écrou SW 36	6 Nm	Anschlussseite gesteckt/ connector fitted/ connexions IP 67  Schaltraum/ switch chamber/ contact IP 67  Betätigungsseite/ button top/ face d'actionnement IP 64
	II				
	III				
	IV				
	V (nur/only/ seulement AE)				
	VI (nur/only/ seulement AE)				
	VII (nur/only/ seulement AB)				
	VIII (nur/only/ seulement AB)				
	IX				
	X				



# Taster

## Push button switches

### Boutons poussoirs

#### 145 ... A . . . .

























<p><b>Zählnummer (wird von elobau vergeben)</b></p> <p><b>Farbe der Tastenkappe</b>          10 = RAL 6017, Maigrün          21 = RAL 1018, Zinkgelb          30 = RAL 2003, Pastellorange          70 = RAL 8002, Signalbraun          40 = RAL 3000, Feuerrot          60 = Schwarz          51 = RAL 5019, Capriblau</p> <p><b>Steckerart</b>          B = mit AMP Super-Seal Stecker          E = mit Deutsch Stecker</p> <p><b>Beschaltung</b>          000 = I          010 = II          100 = III          110 = IV          101 = V (nur AE)          050 = VI (nur AE)          030 = VII (nur AB)          040 = VIII (nur AB)          105 = IX*          115 = X*</p>	<p><b>Counting numbers (issued by elobau)</b></p> <p><b>Actuation cap colour</b>          10 = RAL 6017, may green          21 = RAL 1018, zinc yellow          30 = RAL 2003, pastel orange          70 = RAL 8002, signal brown          40 = RAL 3000, fire ed          60 = black          51 = RAL 5019, capri blue</p> <p><b>connector</b>          B = with AMP Super-Seal connector          E = with Deutsch connector</p> <p><b>Connection</b>          000 = I          010 = II          100 = III          110 = IV          101 = V (AE only)          050 = VI (AE only)          030 = VII (AB only)          040 = VIII (AB only)          105 = IX*          115 = X*</p>	<p><b>Numéros d'article (complété par elobau)</b></p> <p><b>Couleur du capuchon de l'actionneur</b>          10 = RAL 6017, vert printemps          21 = RAL 1018, jaune zinc          30 = RAL 2003, orange pastel          70 = RAL 8002, brun de sécurité          40 = RAL 3000, rouge feu          60 = noir          51 = RAL 5019, bleu capri</p> <p><b>connecteur</b>          B = avec connecteur Super-Seal          E = avec connecteur Deutsch</p> <p><b>Câblage</b>          000 = I          010 = II          100 = III          110 = IV          101 = V (seulement AE)          050 = VI (seulement AE)          030 = VII (seulement AB)          040 = VIII (seulement AB)          105 = IX*          115 = X*</p>
--	---	---

Mutter SW 36 im Lieferumfang enthalten.  
 Mounting nut SW 36 is included in delivery.  
 Ecrou 36 sur plat inclus.

\* Bitte bei der Bestellung Beleuchtungsfarbe angeben (Farben siehe Seite 59)  
 \* When ordering, please specify the illuminated colour (see page 59 for colours)  
 \* Veuillez indiquer la couleur de l'éclairage lors de la commande (voir couleurs page 59)

#### Symbole für Taster 145 ... A. / Symbols for push button switch 145 ... A. / Symboles pour bouton poussoir 145 ... A.

Bitte bei der Bestellung Symbolfarbe angeben (Schwarz oder Weiß) / When ordering, please specify the colour of the symbol (black or white) / Veuillez indiquer la couleur du symbole lors de la commande (noir ou blanc).

<p></p> <p><b>Symbolnr. 01</b></p> <p></p> <p><b>02</b></p> <p></p> <p><b>03</b></p> <p></p> <p><b>04</b></p> <p></p> <p><b>04-1</b></p> <p></p> <p><b>04-2</b></p> <p></p> <p><b>06</b></p> <p></p> <p><b>09</b></p> <p></p> <p><b>12</b></p>	<p></p> <p><b>Symbolnr. 14</b></p> <p></p> <p><b>15</b></p> <p></p> <p><b>18</b></p> <p></p> <p><b>19</b></p> <p></p> <p><b>21</b></p> <p></p> <p><b>23</b></p> <p></p> <p><b>25</b></p> <p></p> <p><b>26</b></p> <p></p> <p><b>27</b></p>	<p></p> <p><b>Symbolnr. 28</b></p> <p></p> <p><b>31</b></p> <p></p> <p><b>38</b></p> <p></p> <p><b>39</b></p> <p></p> <p><b>40</b></p> <p></p> <p><b>45</b></p> <p></p> <p><b>46</b></p> <p></p> <p><b>58</b></p> <p></p> <p><b>64</b></p>	<p></p> <p><b>Symbolnr. 67</b></p> <p></p> <p><b>69-1</b></p> <p></p> <p><b>69</b></p> <p></p> <p><b>70</b></p> <p></p> <p><b>71</b></p> <p></p> <p><b>72</b></p> <p></p> <p><b>73</b></p> <p></p> <p><b>74</b></p> <p></p> <p><b>75</b></p>	<p></p> <p><b>Symbolnr. 76</b></p> <p></p> <p><b>77</b></p> <p></p> <p><b>78</b></p> <p></p> <p><b>79</b></p> <p></p> <p><b>80</b></p> <p></p> <p><b>81</b></p> <p></p> <p><b>82</b></p> <p></p> <p><b>83</b></p>
---	---	---	---	---

# Taster

## Push button switches

### Boutons poussoirs

#### 145 MT ...

**Microtaster**  
**Micro push button switches**  
**Micro boutons poussoirs**



**145 MT..A mit Gewinde M12 / with thread M12 / avec filetage M12**  
**145 MT..B mit LED / with LED / avec LED**

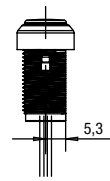
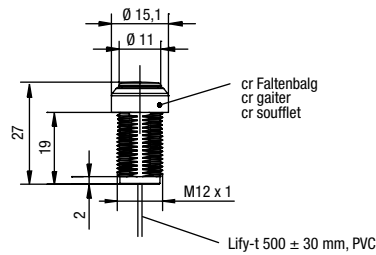

145 MT.A



145 MT.B

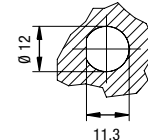

Einbauöffnung  
 mounting hole  
 trou de montage

**145 MT..D mit Rastnase / with snap-in mounting / avec ergot**  
**145 MT..E mit LED / with LED / avec LED**

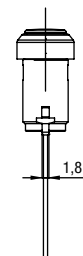
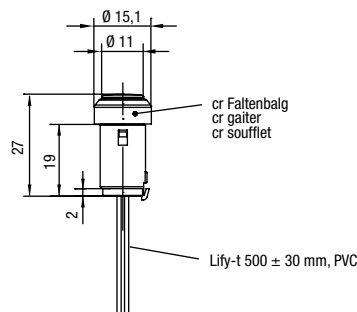

145 MT.D



145 MT.E

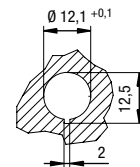

Einbauöffnung  
 mounting hole  
 trou de montage

**Betätigerfarben**  
**Colours**  
**Couleurs**

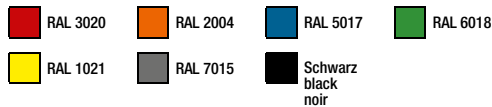

**Beleuchtungsfarben LED**  
**Illumination colours LED**  
**Couleurs d'éclairage LED**

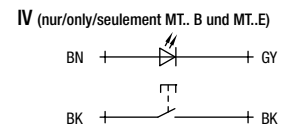
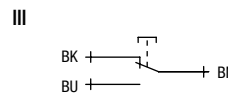
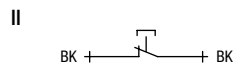
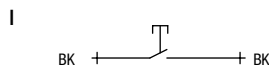

Andere Ausführungen möglich. Bitte fragen Sie an. Es besteht die Möglichkeit, die Tastenkappen mit Symbolen zu bedrucken. Bitte geben Sie das gewünschte Symbol mit der Farbe der Tastenkappe bei der Bestellung an.

Other arrangements available on request. Please enquire. It is possible to have the push button top printed with symbols. Please specify symbol and colour, when ordering.

Contactez-nous pour d'autres réalisations. Le symbole et la couleur du bouton peuvent être choisis sur mesure. Veuillez spécifier ces caractéristiques lors de la commande.

# Taster

## Push button switches

## Boutons poussoirs

### 145 MT ... Microtaster

#### Micro push button switches

#### Micro boutons poussoirs

Typen Nr. type no. référence	Schaltbild circuit diagram schéma de circuit	Schaltspannung switching voltage tens. de commut.	Schaltstrom switching current cour. de commut.	Schaltleistung switching power pouvoir de coup.	LED LED affichage	UB LED UB LED affichage UB	Kontaktart contact form type de contact
145 MT ...	I	max. 48 V	max. 0,5 A	max. 10 W / 10 VA	nein/ no/ non	-	Schließer/ N.O./ NO (I)
	II, III	max. 48 V	max. 0,2 A	max. 1 W / 1 VA			Öffner/N.C./ NF (II) Wechsler/C.O./ inverseur (III)
	IV	max. 24 V	max. 0,1 A	max. 1 W / 1 VA	ja/ yes/ oui	max. 48 V, bedingt durch Vorwiderstand / max. 48 V, conditional to series resistor / maxi 48 V, conditionné par la résistance en série	Schließer/ N.O./ NO (IV)

Typen Nr. type no. référence	Tastenhub button stroke course totale du bouton	Temperaturbereich temperature range plage de température	Schutzart protection class protection	Befestigungsart mounting type méthode de fixation	Anzugsdrehmoment tightening torque couple de serrage
145 MT ..A	2,5 mm	-25°C...+85°C	Elektronik/electronic/ électronique IP 67 Mechanik/mechanism/ mécanique IP 65	Mutter SW 17 screw SW 17	1,5 Nm
145 MT ..B				écrou SW 17	
145 MT ..D				Rastnase snap-in	---
145 MT ..E				ergot	

**145 MT . . . . .**























































<p><b>Zählnummer (wird von elobau vergeben)</b></p> <p><b>Gehäuse</b>          A = M12x1 ohne LED          B = M12x1 mit LED*          D = ø12 mit Rastnase;          ohne LED          E = ø12 mit Rastnase;          mit LED*</p> <p><b>Kontaktart</b>          0 = Schließer          1 = Öffner          2 = Wechsler</p> <p><b>Anschlussart</b>          0 = Litzenabgang          1 = Litzenabgang mit Stecker          3 = Kabelabgang</p>	<p><b>Counting numbers (issued by elobau)</b></p> <p><b>housing</b>          A = M12x1 without LED          B = M12x1 with LED*          D = ø12 with snap-on mounting;          without LED          E = ø12 with snap-on mounting;          with LED*</p> <p><b>contact form</b>          0 = N.O.          1 = N.C.          2 = C.O.</p> <p><b>conductor</b>          0 = wires connection          1 = wires connection with connector          3 = cable connection</p>	<p><b>numéros d'article (complété par elobau)</b></p> <p><b>boîtier</b>          A = M12x1 sans LED          B = M12x1 avec LED*          D = ø12 avec ergot d'enclenchement          sans LED          E = ø12 avec ergot d'enclenchement          avec LED*</p> <p><b>type de contact</b>          0 = NO          1 = NF          2 = inverseur</p> <p><b>section de raccordement</b>          0 = sortie de fil          1 = sortie de fil avec connecteur          3 = départ de câble</p>
---	---	---

Mutter SW 17 im Lieferumfang enthalten.  
 Mounting nut SW 17 is included in delivery.  
 Ecrou 17 sur plat inclus.

\* Bitte bei der Bestellung Beleuchtungsfarbe angeben (Farben siehe Seite 62)  
 \* When ordering, please specify the illuminated colour (see page 62 for colours)  
 \* Veuillez indiquer la couleur de l'éclairage lors de la commande (voir couleurs page 62)

**Symbole für Taster 145 MT ... / Symbols for push button switch 145 MT ... / Symboles pour bouton poussoir 145 MT ...**

Bitte bei der Bestellung Symbolfarbe angeben (Schwarz oder Weiß) / When ordering, please specify the colour of the symbol (black or white) / Veuillez indiquer la couleur du symbole lors de la commande (noir ou blanc).

Symbolnr.									
	01	02	03	04	05	06	07	08	09
Symbolnr.									
	10	11	12	14	15	16	17	18	19
Symbolnr.									
	20	21	22	23	24	25	26	27	30
Symbolnr.									
	31	32	33	34	35	36	37	38	39
Symbolnr.									
	40	41	42	43	44	45	46	47	48
Symbolnr.									
	49	50	51	52	59	60	61	62	

# Taster

## Push button switches

### Boutons poussoirs



**145 MR.....**  
**145 MG.....**

**Microtaster mit Nacht- und Funktionsbeleuchtung**  
**Micro push button switches with night and function lighting**  
**Micro boutons poussoirs avec éclairage de nuit et éclairage de fonction**

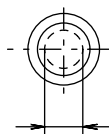
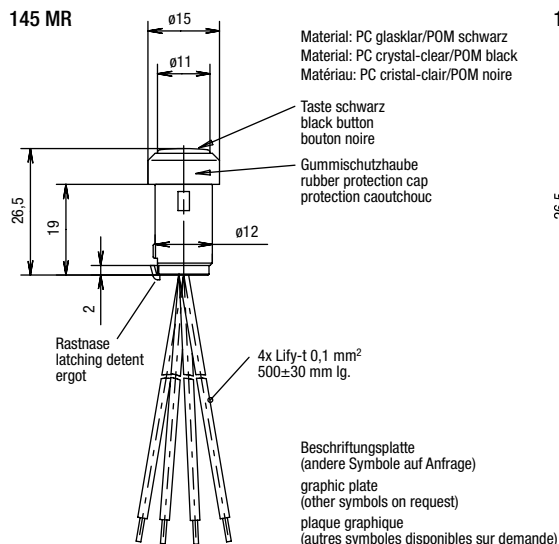

Leuchtfeld max. ø8  
light area max. ø8  
champ lumineux ø max. 8

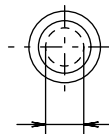
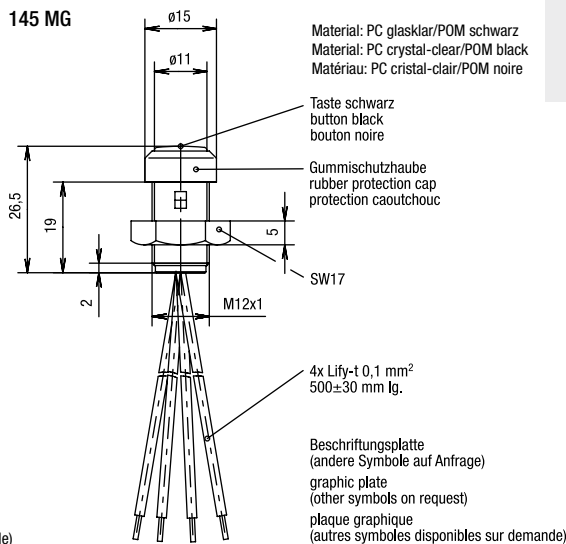

Leuchtfeld max. ø8  
light area max. ø8  
champ lumineux ø max. 8

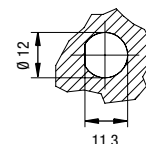

Einbauöffnung  
mounting hole  
trou de montage

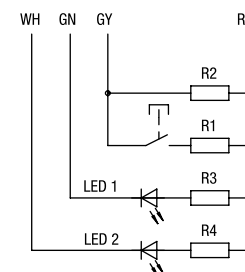

LED 1 Funktionsbeleuchtung  
functional lightning  
éclairage de fonction

LED 2 Nachtdesign  
night design  
design de nuit

### Betätigerfarben Colours Couleurs

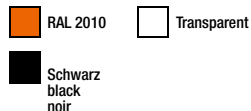

### Nacht- und Funktionsbeleuchtung Night and function lighting Éclairage de nuit et éclairage de fonction



Typen Nr. type no. référence	Schaltspannung switching voltage tension de commut.	Schaltstrom switching current courant de commut.	Schaltleistung switching power pouvoir de coupure	UB LED UB LED affichage UB	Kontaktart contact form type de contact
145 MR.....	16 V AC/DC	max. 0,1 A	max. 1 W / 1 VA	max. 24 V bedingt durch Vorwiderstand max 24 V conditional to series resistor maxi 24 V conditionné par la résistance en série	Schließer/N.O./NO
145 MG.....					







































Typen Nr. type no. référence	Tastenhub button stroke course totale du bouton	Temperaturbereich temperature range plage de température	Schutzart protection class protection	Befestigungsart mounting type méthode de fixation	Anzugsdrehmoment tightening torque couple de serrage
145 MR.....	2,5 mm	-25°C...+85°C	Elektronik/electronic/ électronique IP 67 Mechanik/mechanism/ mécanique IP 65	Rastnase snap-in ergot	-
145 MG.....				Mutter SW 17 screw SW 17 écrou SW 17	

**145 . 0 A . . 1 . . .**

<p><b>Zählnummer (wird von elobau vergeben)</b>  <b>Tastenfarbe</b>          0 = Schwarz          1 = Signalorange          9 = transparent</p> <p><b>Vorwiderstand LED</b>          1 = 470 Ω Vorwid. LED1,          750 Ω LED2          2 = 750 Ω LED</p> <p><b>Namurbeschaltung</b>          1 = 3,6 kΩ Serien-,          18 kΩ Parallelwiderstand</p> <p><b>Farbe LED2</b>          B = Blau          G = Grün          N = nicht bestückt          R = Rot          W = Weiß          Y = Gelb</p> <p><b>Farbe LED1</b>          B = Blau          G = Grün          R = Rot          W = Weiß          Y = Gelb</p> <p><b>Kontaktart</b>          A = SchließBer</p> <p><b>Anschlussart</b>          0 = Litzenabgang, 500 mm</p> <p><b>Befestigungsart</b>          MR = Rastnase ø 12 mm          MG = Gewinde M12x1</p>	<p><b>Counting numbers (issued by elobau)</b>  <b>button</b>          0 = black          1 = signal orange          9 = transparent</p> <p><b>series resistor LED</b>          1 = 470 Ω series resistor LED1,          750 Ω LED2          2 = 750 Ω LED</p> <p><b>Namur circuit</b>          1 = 3,6 kΩ series resistor,          18 kΩ parallel resistor</p> <p><b>colour LED2</b>          B = blue          G = green          N = blank          R = red          W = white          Y = yellow</p> <p><b>colour LED1</b>          B = blue          G = green          R = red          W = white          Y = yellow</p> <p><b>contact form</b>          A = N.O.</p> <p><b>connection</b>          0 = wired connection, 500 mm</p> <p><b>mounting type</b>          MR = locking lug ø 12 mm          MG = M12x1 thread</p>	<p><b>numéros d'article (complété par elobau)</b>  <b>couleur de touche</b>          0 = noir          1 = orange signalisation          9 = transparent</p> <p><b>résistance en série</b>          1 = rés. préél. 470 Ω LED 1,          750 Ω LED 2          2 = 750 Ω LED</p> <p><b>circuit de protection de Namur</b>          1 = résist. série 3,6 kΩ,          parallèle 18 kΩ</p> <p><b>couleur LED2</b>          B = bleu          G = vert          N = non équipée          R = rouge          W = blanc          Y = jaune</p> <p><b>couleur LED1</b>          B = bleu          G = vert          R = rouge          W = blanc          Y = jaune</p> <p><b>type de contact</b>          A = NO</p> <p><b>section de raccordement</b>          0 = sortie de fil, 500 mm</p> <p><b>méthode de fixation</b>          MR = ergot d'enclenchement ø 12 mm          MG = filetage M12x1</p>
--	---	--

Mutter SW 17 im Lieferumfang enthalten.  
 Mounting nut SW 17 is included in delivery.  
 Ecrou 17 sur plat inclus.

**Symbole für Taster 145 MR/MG ... / Symbols for push button switch 145 MR/MG ... / Symboles pour bouton poussoir 145 MR/MG ...**  
 (beleuchtet / illuminated / éclairée)

<p>  <b>Symbolnr.</b> 01</p> <p>  <b>Symbolnr.</b> 02</p> <p>  <b>Symbolnr.</b> 10</p> <p>  <b>Symbolnr.</b> 11</p> <p>  <b>Symbolnr.</b> 12</p> <p>  <b>Symbolnr.</b> 13</p> <p>  <b>Symbolnr.</b> 14</p> <p>  <b>Symbolnr.</b> 17</p> <p>  <b>Symbolnr.</b> 18</p> <p>  <b>Symbolnr.</b> 19</p>	<p>  <b>Symbolnr.</b> 20</p> <p>  <b>Symbolnr.</b> 21</p> <p>  <b>Symbolnr.</b> 22</p> <p>  <b>Symbolnr.</b> 23</p> <p>  <b>Symbolnr.</b> 24</p> <p>  <b>Symbolnr.</b> 25</p> <p>  <b>Symbolnr.</b> 26</p> <p>  <b>Symbolnr.</b> 27</p> <p>  <b>Symbolnr.</b> 28</p> <p>  <b>Symbolnr.</b> 29</p>	<p>  <b>Symbolnr.</b> 30</p> <p>  <b>Symbolnr.</b> 31</p> <p>  <b>Symbolnr.</b> 32</p> <p>  <b>Symbolnr.</b> 33</p> <p>  <b>Symbolnr.</b> 34</p> <p>  <b>Symbolnr.</b> 35</p> <p>  <b>Symbolnr.</b> 36</p> <p>  <b>Symbolnr.</b> 37</p> <p>  <b>Symbolnr.</b> 38</p> <p>  <b>Symbolnr.</b> 39</p>	<p>  <b>Symbolnr.</b> 40</p> <p>  <b>Symbolnr.</b> 41</p> <p>  <b>Symbolnr.</b> 42</p> <p>  <b>Symbolnr.</b> 43</p> <p>  <b>Symbolnr.</b> 44</p> <p>  <b>Symbolnr.</b> 45</p> <p>  <b>Symbolnr.</b> 46</p> <p>  <b>Symbolnr.</b> 47</p> <p>  <b>Symbolnr.</b> 48</p>
---	---	---	---

# Taster Push button switches Boutons poussoirs

145 NTG .....

**Nanotaster**  
Nano push button  
Boutons poussoirs nano

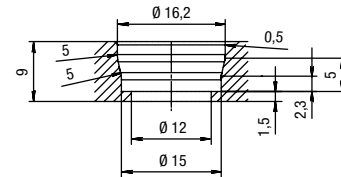
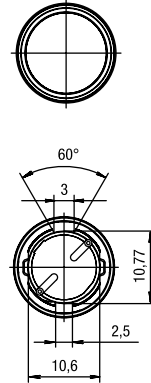
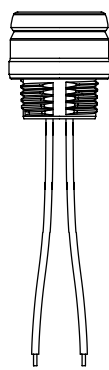
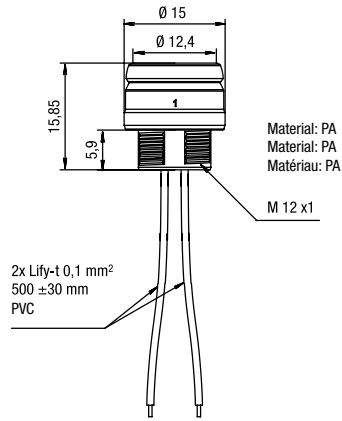

Einbauöffnung  
mounting hole  
trou de montage

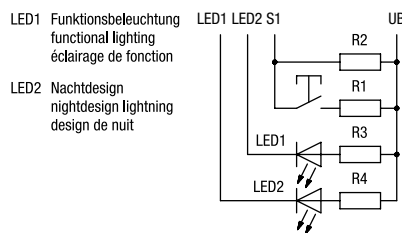
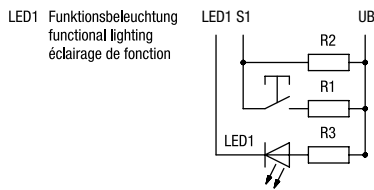

**Betätigerfarben**  
Colours  
Couleurs

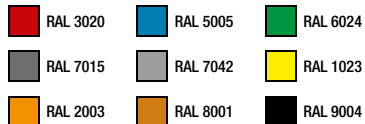

**Beleuchtungsfarben LED**  
Illumination colours LED  
Couleurs d'éclairage LED



Andere Ausführungen möglich. Bitte fragen Sie an. Es besteht die Möglichkeit, die Tastenkappen mit Symbolen zu bedrucken. Bitte geben Sie das gewünschte Symbol mit der Farbe der Tastenkappe bei der Bestellung an (Symbol Ø 10 mm).

Other arrangements available on request. Please enquire. It is possible to have the button top printed with symbols. Please specify symbol and colour, when ordering (symbol Ø 10 mm).

Contactez-nous pour d'autres réalisations. Le symbole et la couleur du bouton peuvent être choisis sur mesure. Veuillez spécifier ces caractéristiques lors de la commande (symbole Ø 10 mm).

Typen Nr. type no. référence	Schaltspannung switching voltage tension de commut.	Schaltstrom switching current courant de commut.	Schaltleistung switching power pouvoir de coupure	LED LED affichage	Kontaktart contact form type de contact
145 NTG .....	max. 48 V	max. 0,3 A	max. 5 W/VA	je nach Vorwiderstand depending on series resistor dependant de résistance de série	Schließer/N.O./NO

Typen Nr. type no. référence	Tastenhub button stroke course totale du bouton	Temperaturbereich temperature range plage de température	Schutzart protection class protection	Befestigungsart mounting type méthode de fixation	Anzugsdrehmoment tightening torque couple de serrage
145 NTG .....	2,15 mm	-40...+85°C	IP 67	Rändelmutter/Mutter SW 17 knurled screw/screw SW 17 écrou moleté/écrou SW 17	0,5 Nm

**145NTG . . . . .**

<p>Zählnummer (wird von elobau vergeben)</p> <p><b>Betätigerkappe</b>  RT = RAL 3020, Verkehrsrot  BL = RAL 5005, Signalblau  GN = RAL 6024, Verkehrsgrün  GE = RAL 1023, Verkehrsgelb  SW = RAL 9004, Signalschwarz  OR = RAL 2003, Pastellorange  HG = RAL 7042, Verkehrsgrau A  DG = RAL 7015, Schiefergrau  (Weitere Farben nach Rücksprache möglich)</p> <p><b>Beschaltung</b>  0 = Standard Schließerkontakt  1 = Namurbeschaltung</p> <p><b>LED</b>  0 = ohne LED  1 = eine LED*  2 = zwei LEDs*</p> <p><b>Gehäuse Gewinde</b></p>	<p>counting numbers (issued by elobau)</p> <p><b>labelling cap</b>  RT = RAL 3020, traffic red  BL = RAL 5005, signal blue  GN = RAL 6024, traffic green  GE = RAL 1023, traffic yellow  SW = RAL 9004, signal black  OR = RAL 2003, pastel orange  HG = RAL 7042, traffic grey A  DG = RAL 7015, slate grey  (other colours available on request)</p> <p><b>connection</b>  0 = standard N.O.  1 = Namur wiring</p> <p><b>LED</b>  0 = without LED  1 = one LED*  2 = two LEDs*</p> <p><b>thread housing</b></p>	<p>numéros d'article (complété par elobau)</p> <p><b>capuchon de l'actionneur</b>  RT = RAL 3020, rouge signalisation  BL = RAL 5005, bleu signalisation  GN = RAL 6024, vert signalisation  GE = RAL 1023, jaune signalisation  SW = RAL 9004, noir de sécurité  OR = RAL 2003, orange pastel  HG = RAL 7042, gris signalisation A  DG = RAL 7015, gris ardoise  (d'autres couleurs sur demande)</p> <p><b>câblage</b>  0 = NF standard  1 = câblage Namur</p> <p><b>LED</b>  0 = sans LED  1 = une LED*  2 = deux LED*</p> <p><b>boîtier fileté M12</b></p>
---	---	---

\* Bitte bei der Bestellung Beleuchtungsfarbe angeben (Farben siehe Seite 67)  
\* When ordering, please specify the illuminated colour (see page 67 for colours)  
\* Veuillez indiquer la couleur de l'éclairage lors de la commande (voir couleurs page 67)

**Bitte wählen Sie die Befestigungsart und bestellen Sie separat:**  
**Please choose mounting type and order seperately:**  
**Veillez choisir méthode de fixation et commander séparément:**



Typen Nr. / type no. / référence 856107  
Rändelmutter / knurled screw / écrou moleté

oder / or / ou























Typen Nr. / type no. / référence 871840  
Mutter SW 17 / screw SW 17 / écrou 17 sur plat



**145 NTG .....**

Symbole für Taster 145 NTG ... / Symbols for push button switch 145 NTG ... / Symboles pour bouton poussoir 145 NTG ...

							
Symbolnr.	<b>01</b>	<b>03</b>	<b>04</b>	<b>05</b>	<b>06</b>	<b>15</b>	<b>16</b>
	RAL 6024 Verkehrsgrün traffic green vert signalisation	RAL 5005 Signalblau signal blue bleu signalisation	RAL 1023 Verkehrsgelb traffic yellow jaune signalisation	RAL 9004 Signalschwarz signal black noir de sécurité	RAL 9004 Signalschwarz signal black noir de sécurité	RAL 5005 Signalblau signal blue bleu signalisation	RAL 9004 Signalschwarz signal black noir de sécurité
							
Symbolnr.	<b>17</b>	<b>18</b>	<b>19</b>	<b>20</b>	<b>21</b>	<b>22</b>	<b>23</b>
	RAL 9004 Signalschwarz signal black noir de sécurité	RAL 9004 Signalschwarz signal black noir de sécurité	RAL 9004 Signalschwarz signal black noir de sécurité	RAL 9004 Signalschwarz signal black noir de sécurité	RAL 1023 Verkehrsgelb traffic yellow jaune signalisation	RAL 9004 Signalschwarz signal black noir de sécurité	RAL 9004 Signalschwarz signal black noir de sécurité
							
Symbolnr.	<b>24</b>	<b>25</b>	<b>26</b>	<b>35</b>	<b>48</b>	<b>49</b>	<b>55</b>
	RAL 9004 Signalschwarz signal black noir de sécurité	RAL 9004 Signalschwarz signal black noir de sécurité	RAL 5005 Signalblau signal blue bleu signalisation	RAL 5005 Signalblau signal blue bleu signalisation	RAL 5005 Signalblau signal blue bleu signalisation	RAL 5005 Signalblau signal blue bleu signalisation	RAL 7042 Verkehrsgrau A traffic grey A gris signalisation A

# Taster

## Push button switches

### Boutons poussoirs

145 MA.....

Microtaster analog  
 Analogue micro push button  
 Micro boutons poussoirs analogique

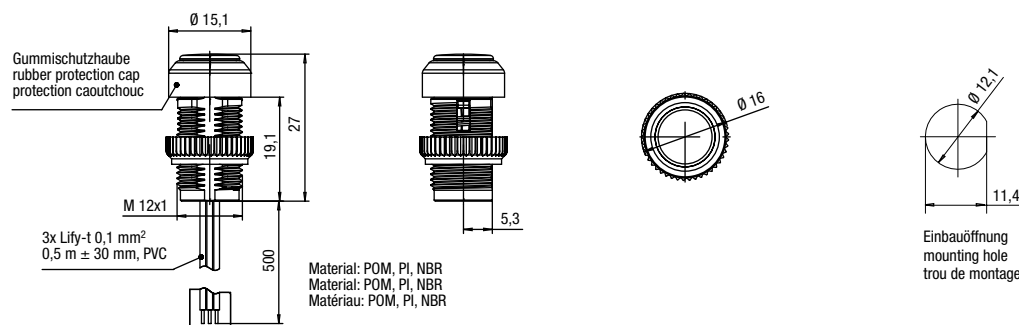
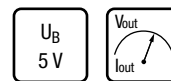

Ratiometrisch analog  
 ratiometric analogue  
 proportionnel analogique

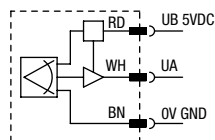

Betätigerfarben  
 Colours  
 Couleurs

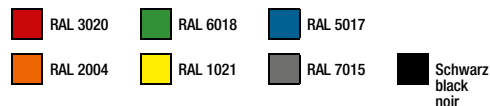

Andere Ausführungen möglich. Bitte fragen Sie an. Es besteht die Möglichkeit, die Tastenkappen mit Symbolen zu bedrucken. Bitte geben Sie das gewünschte Symbol mit der Farbe der Tastenkappe bei der Bestellung an.

Other arrangements available on request. Please enquire. It is possible to have the button top printed with symbols. Please specify symbol and colour, when ordering.

Contactez-nous pour d'autres réalisations. Le symbole et la couleur du bouton peuvent être choisis sur mesure. Veuillez spécifier ces caractéristiques lors de la commande.

Typen Nr. type no. référence	Betriebsspannung operating voltage tension d'alimentation	Betriebsstrom operating current courant d'alimentation	Ausgangssignal output signal signal de sortie	Nullstellung zero position zéro
145 MA.....	4,5 ... 5,5 V	max. 15 mA	0,5...4,5 V DC	0,5 V DC ± 0,15 V

Typen Nr. type no. référence	LED LED affichage	Kontaktart contact form type de contact	Lastwiderstand load resistance résistance de charge	Tastenhub button stroke course totale du bouton
145 MA.....	nein/no/non	analog/analogue/analogique	> 20 kΩ	4 mm ± 0,25 mm

Typen Nr. type no. référence	Temperaturbereich temperature range plage de température	Schutzart protection class protection	Befestigungsart mounting type méthode de fixation	Anzugsdrehmoment tightening torque couple de serrage
145 MA.....	-40...+85°C	Elektronik/electronic/électronique IP 67 Mechanik/mechanism/mécanique IP 65	Rändelmutter knurled screw écrou moleté	1,5 Nm

# Taster

## Push button switches

### Boutons poussoirs

145 MA 0 0 A ...

Zählnummer (wird von elobau vergeben)	counting numbers (issued by elobau)	numéros d'article (complété par elobau)
<b>Betätigerkappe</b> 01 = RAL 5017, Verkehrsblau 03 = RAL 3020, Verkehrsrot 05 = RAL 7015, Schiefergrau 06 = Schwarz 07 = RAL 1021, Rapsgebl 08 = RAL 6018, Gelbgrün 10 = RAL 2004, Reinorange	<b>actuator cap</b> 01 = RAL 5017, traffic blue 03 = RAL 3020, traffic red 05 = RAL 7015, slate grey 06 = black 07 = RAL 1021, rape yellow 08 = RAL 6018, yellow-green 10 = RAL 2004, pure orange	<b>capuchon de l'actionneur</b> 01 = RAL 5017, bleu signalisation 03 = RAL 3020, rouge signalisation 05 = RAL 7015, gris ardoise 06 = noir 07 = RAL 1021, jaune colza 08 = RAL 6018, vert jaune 10 = RAL 2004, orangé pur
<b>Gehäuse</b> A = Gehäuse M12x1	<b>housing</b> A = housing M12x1	<b>boîtier</b> A = boîtier M12x1
Ausgangssignal 0,5 – 4,5 V DC	output signal 0,5 – 4,5 V DC	signal de sortie 0,5 – 4,5 V DC
<b>Anschlussart</b> 0 = Litzenabgang	<b>connection</b> 0 = wired connection	<b>section de raccordement</b> 0 = sortie de fil

Rändelmutter im Lieferumfang enthalten.  
Knurled screw is included in delivery.  
Ecroû moleté inclus.

#### Symbole für Taster 145 MA ... / Symbols for push button switch 145 MA ... / Symboles pour bouton poussoir 145 MA ...

Bitte bei der Bestellung Symbolfarbe angeben (Schwarz oder Weiß) / When ordering, please specify the colour of the symbol (black or white) / Veuillez indiquer la couleur du symbole lors de la commande (noir ou blanc).

Symbolnr. 01	02	03	04	05	06	07	08	09
Symbolnr. 10	11	12	14	15	16	17	18	19
Symbolnr. 20	21	22	23	24	25	26	27	30
Symbolnr. 31	32	33	34	35	36	37	38	39
Symbolnr. 40	41	42	43	44	45	46	47	48
Symbolnr. 49	50	51	52	59	60	61	62	

# Taster

## Push button switches

## Boutons poussoirs

145 MD4.A..

Doppeltaste  
Double push button  
Bouton poussoir double

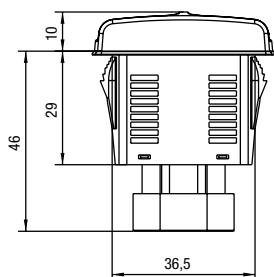
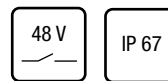

Material: PBT/NBR  
Material: PBT/NBR  
Matériau: PBT/NBR

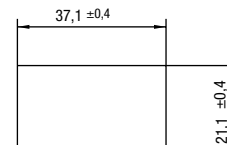
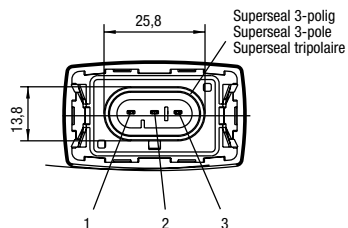
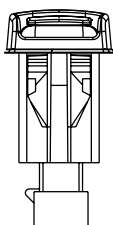

Blechstärke 3-5 mm  
sheet thickness 3-5 mm  
épaisseur 3-5 mm

Einbauöffnung  
mounting hole  
trou de montage

Tastenfarbe und Symbol nach Kundenwunsch  
Please specify symbol and colour, when ordering  
Couleur et symbole à spécifier

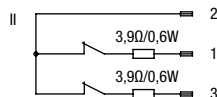
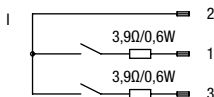
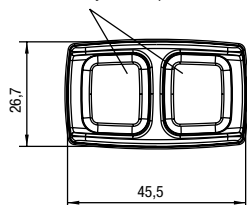

Andere Ausführungen möglich. Bitte fragen Sie an. Es besteht die Möglichkeit, die Tastenkappen mit Symbolen zu bedrucken. Bitte geben Sie das gewünschte Symbol mit der Farbe der Tastenkappe bei der Bestellung an.

Other arrangements available on request. Please enquire. It is possible to have the button top printed with symbols. Please specify symbol and colour, when ordering.

Contactez-nous pour d'autres réalisations. Le symbole et la couleur du bouton peuvent être choisis sur mesure. Veuillez spécifier ces caractéristiques lors de la commande.

Typen Nr. type no. référence	Schaltspannung switching voltage tension de commutation	Schaltstrom switching current courant de commutation	Schaltleistung switching power pouvoir de coupure	Dauerstrom continuous current courant traversant	Tastenhub button stroke course totale du bouton
145 MD4. A..	max. 48 V	max. 0,5 A	max. 10 W / 10 VA	350 mA	3 mm

Typen Nr. type no. référence	Kontaktart contact form type de contact	Schaltbild circuit diagram schéma de circuit	Beschaltung wiring résistance série	Temperaturbereich temperature range plage de température
145 MD40 A..	2 × Schließer / 2 × N.O. / 2 × NO	I	3,9 Ω / 0,6 W	-35...+70°C
145 MD41 A..	2 × Öffner / 2 × N.C. / 2 × NF	II		

	Schutzart protection class protection
Anschlussseite gesteckt/connector fitted/connexions	IP 67
Schaltraum/switch chamber/contact	IP 67
Betätigungsseite/button top/face d'actionnement	IP 64

# Taster

## Push button switches

### Boutons poussoirs

145 DW4.A..

Micro-Wipptaste  
Micro-rocker-switch  
Micro-bouton à bascule

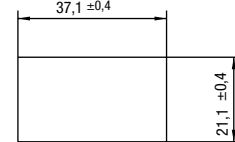
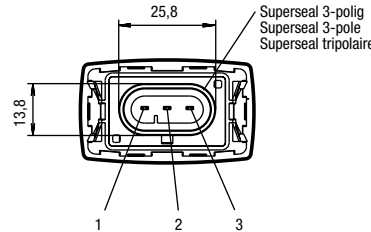
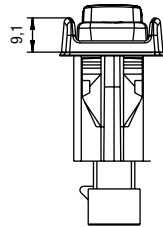
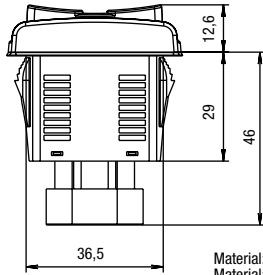
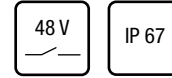

Material: PBT/NBR  
Material: PBT/NBR  
Matériau: PBT/NBR

Blechstärke 3-5 mm  
sheet thickness 3-5 mm  
épaisseur 3-5 mm

Einbauöffnung  
mounting hole  
trou de montage

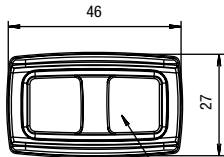

Tastenkappe schwarz – Symbol nach Kundenwunsch  
Push button cap colour black – Symbol according to customer request  
Bouton noir – symbole à spécifier

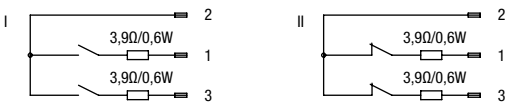

Andere Ausführungen möglich. Bitte fragen Sie an. Es besteht die Möglichkeit, die Tastenkappen mit Symbolen zu bedrucken. Bitte geben Sie das gewünschte Symbol mit der Farbe der Tastenkappe bei der Bestellung an.

Other arrangements available on request. Please enquire. It is possible to have the button top printed with symbols. Please specify symbol and colour, when ordering.

Contactez-nous pour d'autres réalisations. Le symbole et la couleur du bouton peuvent être choisis sur mesure. Veuillez spécifier ces caractéristiques lors de la commande.

Typen Nr. type no. référence	Schaltspannung switching voltage tension de commutation	Schaltstrom switching current courant de commutation	Schaltleistung switching power pouvoir de coupure	Dauerstrom continuous current courant traversant	Tastenhub button stroke course totale du bouton
145 DW4. A..	max. 48 V	max. 0,5 A	max. 10 W / 10 VA	350 mA	3 mm

Typen Nr. type no. référence	Kontaktart contact form type de contact	Schaltbild circuit diagram schéma de circuit	Beschaltung wiring résistance série	Temperaturbereich temperature range plage de température
145 DW40 A..	2 × Schließer / 2 × N.O. / 2 × NO	I	3,9 Ω / 0,6 W	-35...+70°C
145 DW41 A..	2 × Öffner / 2 × N.C. / 2 × NF	II		

	Schutzart protection class protection
Anschlussseite gesteckt/connector fitted/connexions	IP 67
Schaltraum/switch chamber/contact	IP 67
Betätigungsseite/button top/face d'actionnement	IP 64

# Taster

## Push button switches

## Boutons poussoirs



**145 PTO 10 .00**

**PTO-Taster mit Super-Seal-Stecker**  
**PTO with Super-Seal connector**  
**Bouton PTO avec connecteur Super-Seal**

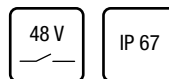

**145PT010A00** PTO-Taster mit Kabel  
 PTO with cable  
 Bouton PTO avec câble

**145PT010B00** PTO-Taster mit Super-Seal-Stecker  
 PTO with Super-Seal connector  
 Bouton PTO avec connecteur Super-Seal

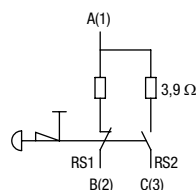
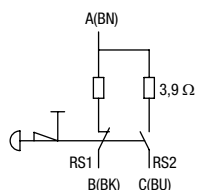
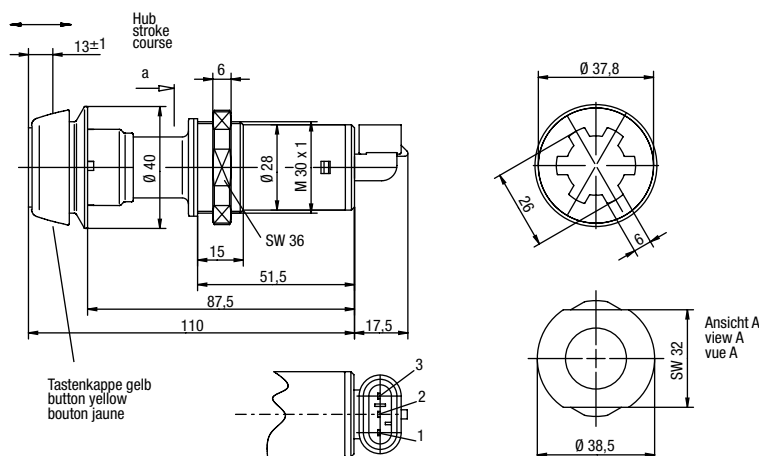
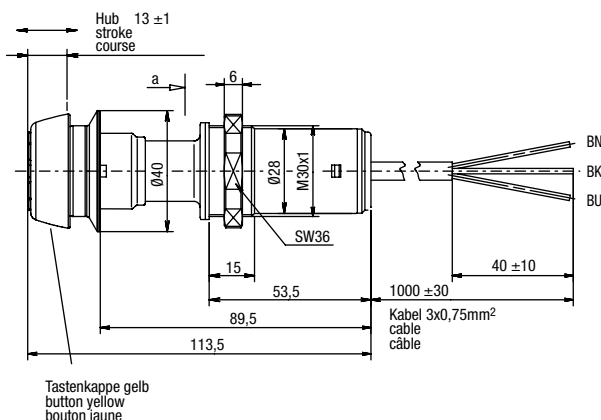

	PTO OFF	Taste gedrückt button pushed down bouton pressé	PTO ON	Taste hochgezogen button pulled up bouton levé
A - B		1		0
A - C		0		1

Mutter SW 36 im Lieferumfang enthalten.  
 Mounting nut SW 36 is included in delivery.  
 Ecrou 36 sur plat inclus.

1 = Kontakt geschlossen/contact closed/contact fermé  
 0 = Kontakt offen/contact open/contact ouvert

Typen Nr. type no. référence	Schaltspannung switching voltage tension de commutation	Schaltstrom switching current courant de commutation	Schaltleistung switching power pouvoir de coupure	Dauerstrom continuous current courant traversant	Anschlussart conductor section de raccordement
145PT010B00	max. 48 V	max. 0,5 A	max. 10 W / 10 VA	0,3 A	Super-Seal-Stecker Super-Seal connector connecteur Super-Seal
145PT010A00					Kabel – Kabellänge 1.000 mm cable – cable length 1,000 mm câbles – longueur de câble 1.000 mm

Typen Nr. type no. référence	Kontaktart contact form type de contact	Temperaturbereich temperature range plage de température	Schutzart protection cl. protection	Schutzart Schaltraum protection class switch chamber protection contact	Befestigungsart mounting type méthode de fixation	Anzugsdrehmoment tightening torque couple de serrage
145PT010B00	Schließer/N.O./NO + Öffner/N.C./NF	-25...+85°C	IP 64	IP 67	Mutter SW 36 Screw SW 36 écrou SW 36	6 Nm
145PT010A00			-			

# Taster

## Push button switches

### Boutons poussoirs

#### 151 PTO...

**PTO-Taster mit Beleuchtung**  
**Illuminated PTO**  
**Bouton PTO éclairée**

SIL-  
capable  
EN61508

48 V

IP 67

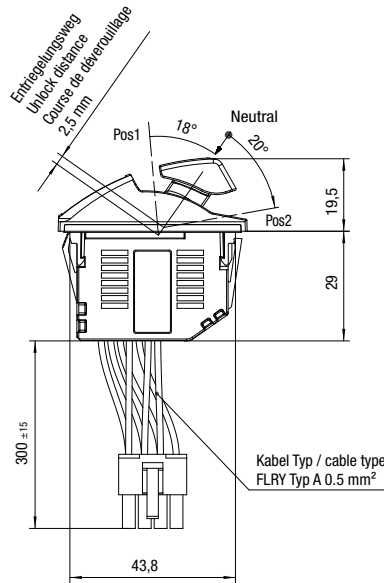

background: pantone black  
symbol: white  
Fond: noir  
Symbole: blanc

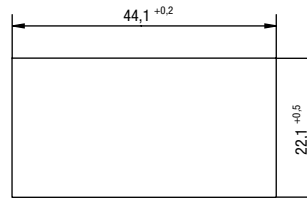
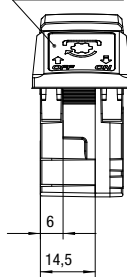

Blechstärke 1,6 ± 0,1 mm  
sheet thickness 1,6 ± 0,1 mm  
épaisseur 1,6 ± 0,1 mm

Einbauöffnung  
mounting hole  
trou de montage

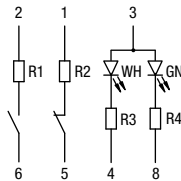
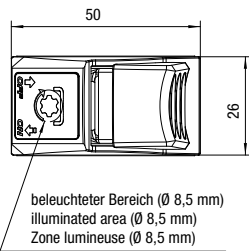

**Beleuchtungsfarben und weitere Betätigerfarben auf Anfrage.**  
**Illuminated colours and other actuator colours on request.**  
**Couleurs de l'éclairage et du bouton sur demande.**

Typen Nr. type no. référence	Schaltspannung switching voltage tension de commutation	Schaltstrom switching current courant de commutation	Dauerstrom continuous current courant traversant	Schaltleistung switching power pouvoir de coupure
151 PTO 16	max. 48 V DC	max. 0,3 A	max. 300 mA	max. 10 W / 10 VA

Typen Nr. type no. référence	Kontaktart contact form type de contact	Temperaturbereich temperature range plage de température	Schutzart Schaltraum protection class switch chamber protection contact	Befestigungsart mounting type méthode de fixation	LED LED LED
151 PTO 16	Schließer/N.O./NO + Öffner/ N.C./NF	-40°...+85° C	IP 67	Clip	ja / yes / oui





# 5

## Stößelschalter Plunger operated switches Interrupteurs poussoirs



Stößelschalter  
Plunger operated switches  
Interrupteurs poussoirs

79...82





# Stößelschalter Plunger operated switches Interrupteurs poussoirs

48 V

IP 67

www.elobau.com

144 002 04

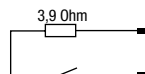
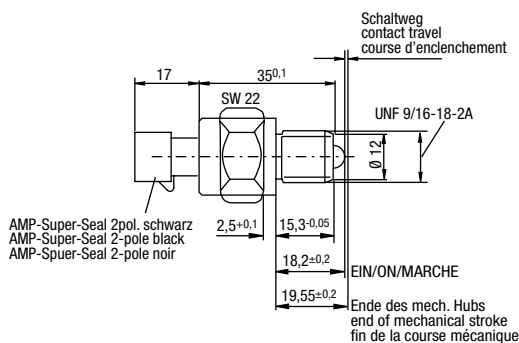

144 015 0201

48 V

IP 67

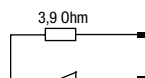
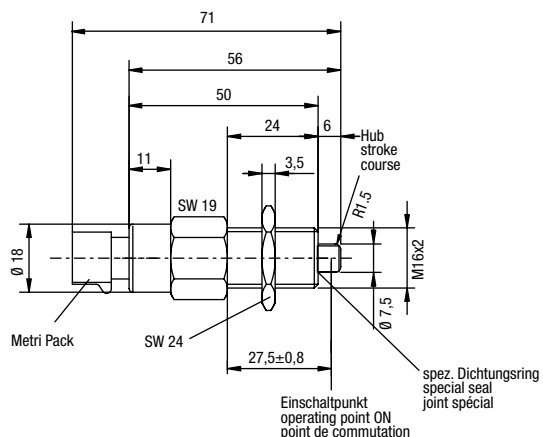

Typen Nr. type no. référence	Schaltspannung switching voltage tension de commutation	Schaltstrom switching current courant de commutation	Schaltleistung switching power pouvoir de coupure	Dauerstrom continuous current courant continu
144 002 04	max. 48 V	0,3 A	10 W / 12 VA	300 mA
144 015 0201		0,5 A		

Typen Nr. type no. référence	Kontaktform contact form type de contact	Schutzart protection class protection	Temperaturbereich temperature range plage de température
144 002 04	Schließer/N.O./NO	IP 67	-25...+130°C
144 015 0201	Öffner/N.C./NF		-30...+100°C

Weitere Ausführungen auf Anfrage! Other versions on request! Autres modèles disponibles sur demande.

Änderungen und Irrtümer bleiben vorbehalten. Abbildungen ähnlich. Maßgeblich sind die dem ausgelieferten Produkt beigelegten technischen Dokumentationen. The relevant corresponding technical documents will be supplied with the product. Certain product descriptions can be similar therefore please ensure that you have the latest version of documentation for your specific product prior to any use. elobau reserves the right to change technical data and documentation without notice. Sous réserve de modifications et d'erreurs. Images similaires. Les documentations techniques accompagnant les produits sont d'application.

made  
in  
Germany

no CO<sub>2</sub>

Wir produzieren klimaneutral.  
We produce in a carbon-neutral manner.  
Nous produisons avec un bilan carbone neutre.

79

# Stößelschalter Plunger operated switches Interrupteurs poussoirs

14401602

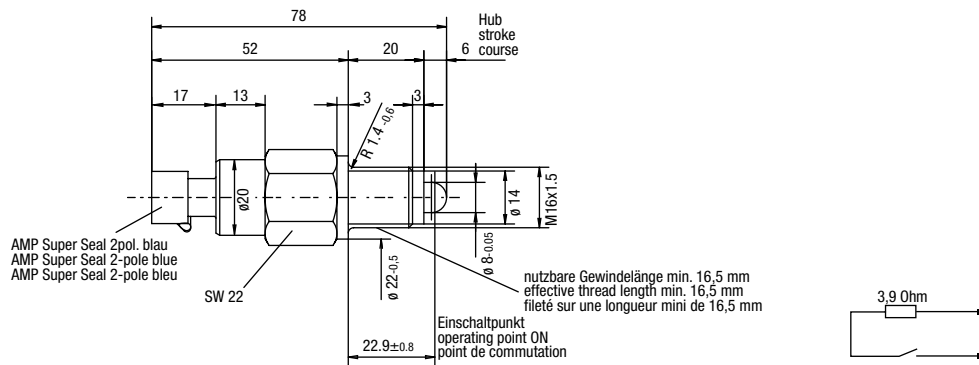

Typen Nr. type no. référence	Schaltspannung switching voltage tension de commutation	Schaltstrom switching current courant de commutation	Schaltleistung switching power pouvoir de coupure	Dauerstrom continuous current courant continu
144 016 02	max. 48 V	0,5 A	10 W / 10 VA	300 mA

Typen Nr. type no. référence	Kontaktform contact form type de contact	Schutzart protection class protection	Anschluß gesteckt connection fitted connexions	Schalter switch interrupteur	Temperaturbereich temperature range plage de température
144 016 02	Schließer/N.O./NO		IP 67	IP 67	-30...+120°C

Weitere Ausführungen auf Anfrage! Other versions on request! Autres modèles disponibles sur demande.

# Stößelschalter Plunger operated switches Interrupteurs poussoirs

14452105

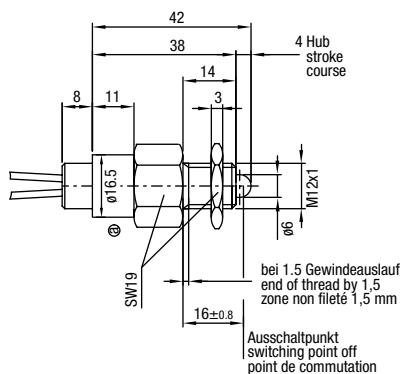
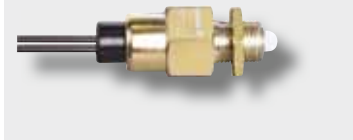

14481001 (PUR-Kabel / cable / câble)

144810V02 (PVC-Kabel / cable / câble, Gehäuse / housing / boîtier VA)

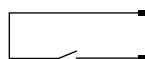
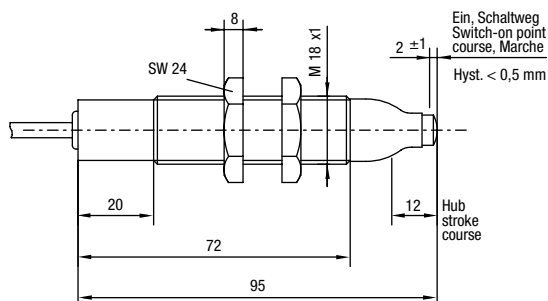

Typen Nr. type no. référence	Schaltspannung switching voltage tension de commutation	Schaltstrom switching current courant de commutation	Schaltleistung switching power pouvoir de coupure	Dauerstrom continuous current courant continu
144 521 05	max. 48 V	0,5 A	5 W / 5 VA	200 mA
144 810 01	max. 230 V	2,5 A	100 W / 100 VA	2,5 A
144 810 V02	max. 250 V	1 A	60 W / 60 VA	1 A

Typen Nr. type no. référence	Kontaktform contact form type de contact	Schutzart protection class protection	Temperaturbereich temperature range plage de température
144 521..	Schließer/N.O./NO	IP 67	-25...+85°C
144 810 01			-25...+75°C
144 810 V02			-25...+75°C

Weitere Ausführungen auf Anfrage! Other versions on request! Autres modèles disponibles sur demande.

Änderungen und Irrtümer bleiben vorbehalten. Abbildungen ähnlich. Maßgeblich sind die dem ausgelieferten Produkt beigelegten technischen Dokumentationen. The relevant corresponding technical documents will be supplied with the product. Certain product descriptions can be similar therefore please ensure that you have the latest version of documentation for your specific product prior to any use. elobau reserves the right to change technical data and documentation without notice. Sous réserve de modifications et d'erreurs. Images similaires. Les documentations techniques accompagnant les produits sont d'application.



Wir produzieren klimaneutral.  
We produce in a carbon-neutral manner.  
Nous produisons avec un bilan carbone neutre.



# 6

## Winkelsensoren Angle sensors DéTECTEURS angulaires



Winkelsensoren mit Kugel- oder Gleitlager  
Angle sensor with plain or ball bearing  
DéTECTEUR angulaire avec palier ou roulement à billes

85...87



Winkelsensor redundant  
Angle sensor with redundancy  
DéTECTEUR angulaire redondant

88...90



Winkelsensor 360°  
Angle sensor 360°  
DéTECTEUR angulaire 360°

91...92



CAN-Winkelsensor  
CAN-angle sensor  
DéTECTEUR angulaire CAN

93...94



Winkelsensor axial  
Axial angle sensor  
DéTECTEUR angulaire axial

95







# Winkelsensoren Angle sensors DéTECTEURS angulaires

## 424 A.. A.... Winkelsensoren mit Kugel- oder Gleitlager Angle sensor with plain or ball bearing DéTECTEUR angulaire avec palier ou roulement à billes

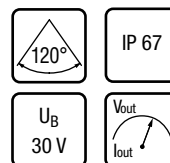

Gehäuse/housing/boîtier  
PBT 45% GF  
schwarz/black/noir

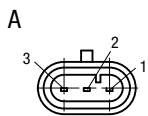
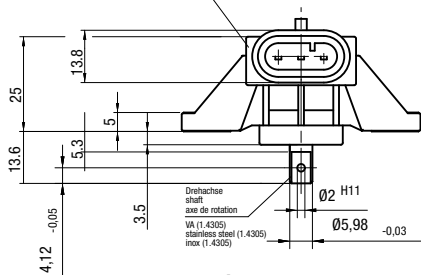

Den passenden Kabelsatz  
(Artikel-Nr L0.C00.B01)  
finden Sie auf Seite 127.  
The matching cable kit  
(order no. L0.C00.B01)  
can be found on page 127.  
Vous trouverez le jeu de câbles  
correspondant  
(N° d'article L0.C00.B01)  
à la page 127.

Ansicht Welle mit Bohrung  
view of shaft with hole for dowel pin  
Vue avec détail de l'axe

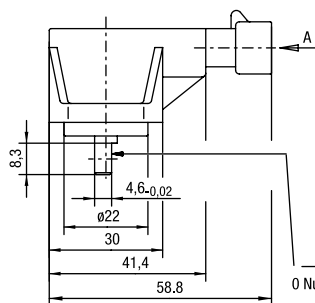

Ansicht Welle mit Hebel  
view of shaft with lever  
Vue avec levier assemblé

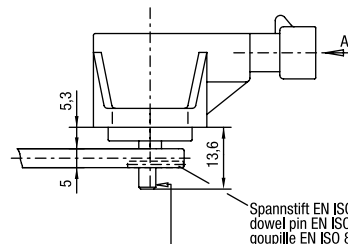

Spannstift EN ISO 8752 ø2x14 A2  
dowel pin EN ISO 8752 ø2x14 A2  
goupille EN ISO 8752 ø2x14 A2

0 Nullstellung: flache Seite der Drehachse ist parallel zur Achse der Befestigungsbuchsen

0 zero position: when flat on shaft is parallel to mounting hole axis

0 position zero: lorsque le plat est parallèle à l'axe des trous de fixation

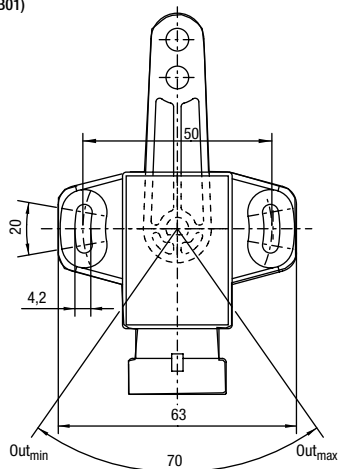

z.B. -35  
e.g.  
p.e.  
z.B. +35  
e.g.  
p.e.

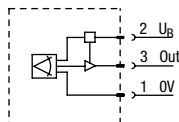

424 A.0 .....  
424 A.6 .....  
424 A.7 .....  
424 A.1 .....  
424 A.2 .....

max. Anzugsmoment für Befestigungsbuchsen mit Unterlegscheibe ø 10 mm: 2,5 Nm  
max. tightening torque for mounting holes with spacers ø10 mm: 2.5 Nm  
couple de serrage max. pour douilles de fixation avec rondelle ø10 mm : 2,5 Nm

## 350 210 Betätigungshebel Actuating lever Levier de commande

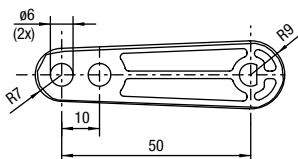

max. Anzugsmoment: 2,5 Nm  
max. tightening torque: 2,5 Nm  
couple de serrage max. : 2,5 Nm

**424 A.. A....**      **Bestellangaben**  
**Ordering information**  
**Page de sélection des spécifications**

**424 A . . A . . . . .**

<p><b>Betätigungshebel</b> B = Hebel montiert</p> <p><b>Winkelmeßbereich</b> 3 Stellen (Wert = Winkel) z.B. 030 = 30 Grad</p> <p><b>Welle</b> A = Standardwelle</p> <p><b>Ausgangssignal*</b> 0 = 1 – 5 V 1 = 4 – 20 mA 2 = 4 – 20 mA/8,5 V 6 = 0,5 – 4,5 V ratiometrisch 7 = 0,5 – 4,5 V</p> <p><b>Lagerung</b> 0 = Gleitlager 1 = Kugellager</p>	<p><b>actuating lever</b> B = lever assembled</p> <p><b>angular measuring range</b> 3 digits (value = angle) e.g. 030 = 30 degree</p> <p><b>Shaft</b> A = standard shaft</p> <p><b>output signal*</b> 0 = 1 – 5 V 1 = 4 – 20 mA 2 = 4 – 20 mA/8,5 V 6 = 0,5 – 4,5 V ratiometric 7 = 0,5 – 4,5 V</p> <p><b>Bearing</b> 0 = plain bearing 1 = ball bearing</p>	<p><b>levier d'actionnement</b> B = levier assemblé</p> <p><b>plage de mesure angulaire</b> 3 positions (valeur = angle) p.e. 030 = 30 degrés</p> <p><b>Axe</b> A = axe standard</p> <p><b>signal de sortie*</b> 0 = 1 – 5 V 1 = 4 – 20 mA 2 = 4 – 20 mA/8,5 V 6 = 0,5 – 4,5 V ratiométrique 7 = 0,5 – 4,5 V</p> <p><b>Billes</b> 0 = palier 1 = roulement à billes</p>
--	--	---

\* Andere Ausgangssignale auf Anfrage / Different output signals on request / D'autres signaux de sortie sur demande.

**Allgemeine Angaben**

Der Winkelmeßbereich liegt zwischen 30° und 120°. Das Messprinzip ist kontaktlos, es basiert auf einem sich um einen Hallsensor drehenden Magnetfeld. Andere Ausgangssignale auf Anfrage. Das System ist kurzschluss-sicher. Der Winkelsensor ist mit einem 3-PIN AMP Superseal 1.5-Stecker ausgerüstet. Es gibt keinen mechanischen Anschlag. Gehäusematerial: PBT.

**General information**

The angular measuring range is between 30° and 120°. The measuring principle is non-contacting (rotating magnetic field over hall-sensor). Other output signals on request. The system is short circuit-proof. The angle sensor is equipped with a 3-PIN AMP Superseal 1.5 plug. There is no mechanical stop. Housing material: PBT.

**Information générale**

La plage de mesure angulaire est entre 30° et 120°. Le principe de mesure est sans contact (champ magnétique tournant sur détecteur à effet Hall). D'autres signaux de sortie sur demande. Le système est protégé contre les courts circuits). Le détecteur est équipé avec un connecteur 3-broches AMP Superseal 1.5. La rotation mécanique de l'axe est illimité. Matériau du boîtier: PBT.

**424 A.. A....**      **Winkelsensoren mit Kugel- oder Gleitlager**  
**Angle sensor with plain or ball bearing**  
**Détecteur angulaire avec palier ou roulement à billes**

Typen Nr. type no. référence	Betriebsspannung operating voltage tension d'alim.	Ausgangssignal output signal signal de sortie	Stromaufnahme current consumption consommation de courant	Auflösung resolution résolution	Lastwiderstand load resistance résistance de charge	Mittelstellung centre position zéro
424 A . 0 A ....	10 – 30 V DC	1 – 5 V	12 V → 18 mA	< 0,1°	> 20 kΩ	3 V
424 A . 1 A ....	10 – 30 V DC	4 – 20 mA	12 V → 18 mA		*	12 mA
424 A . 2 A ....	8,5 V DC	4 – 20 mA	8,5 V → 35 mA		200 Ω → GND	12 mA
424 A . 6 A ....	4,5 – 5,5 V DC	0,5 – 4,5 V ratiom.	5 V → 8 mA		> 20 kΩ	typ. 2,5 V
424 A . 7 A ....	10 – 30 V DC	0,5 – 4,5 V	12 V → 10 mA		> 20 kΩ	typ. 2,5 V

\* bei Betriebsspannung / with operating voltage / avec une tension d'alim. de: 10 V < 250 Ω  
30 V < 1250 Ω

Typen Nr. type no. référence	Verpolschutz reverse connection protected protégé contre inversions de polarité	Verzögerungszeit des Ausgangssignals delay time of output signal temps de retardement signal de sortie	Temperaturbereich temperature range plage de température	Schutzart protection class protection
424 A . 0 A ....	ja/yes/oui	ca./approx./env. 3 ms	-40...+85°C	IP 67
424 A . 1 A ....				
424 A . 2 A ....				
424 A . 6 A ....				
424 A . 7 A ....				

Typische Werte für verschiedene Winkelbereiche (20°C) typical values for different angular ranges (20°C) valeurs typiques pour les plages de mesure angulaire (20°C)	±15°	±25°	±35°	±45°	±60°
typischer Linearitätsfehler (°) linearity error (°) erreur de linearité (°)	±0,2	±0,4	±1,0	±2,0	±5,0
Offset-Temperaturdrift (mV/°C) offset-temperature-drift (mV/°C) déviation offset-température (mV/°C)	1,1	0,3	0,4	0,2	0,5
Offset-Temperaturdrift (µA/°C) offset-temperature-drift (µA/°C) déviation offset-température (µA/°C)	4,4	1,2	1,6	0,8	2,0

# Winkelsensoren Angle sensors DéTECTEURS angulaires

SIL-capable  
EN61508

U<sub>B</sub>  
30 V

V<sub>out</sub>  
I<sub>out</sub>

120°

IP 67

www.elobau.com



**424 R. ...** Winkelsensor mit optionalem 2. Ausgangssignal (redundant) mit AMP-Stecker (Micro Quadlock System) oder Deutsch-Stecker DT04-6P  
**Angle sensor with optional 2. output (redundant) with AMP-connector (Micro Quadlock) or Deutsch-connector DT04-6P**  
**DéTECTEUR angulaire avec 2. sorties optionnelles (redundant) avec connecteur AMP (Micro Quadlock) ou connecteur Deutsch DT04-6P**

## 424 RA

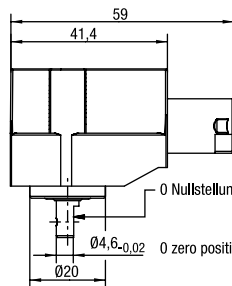
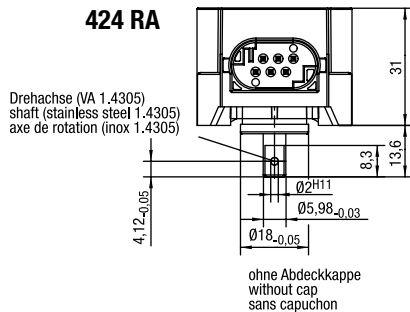

## 424 RD

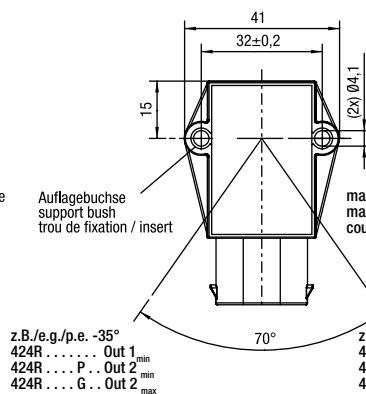
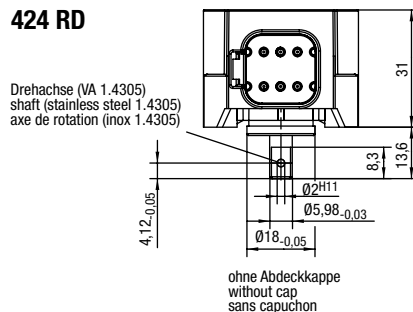

## 424 RA

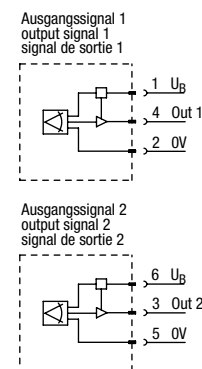

## 424 RD

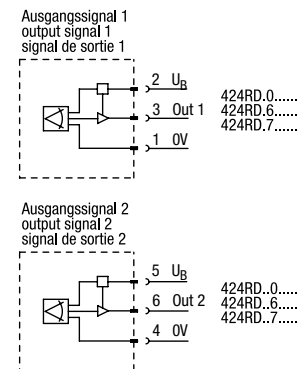

## 424 RA

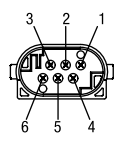

Den passenden Kabelsatz für einen Ausgang (Artikel-Nr LOZD.0.B) finden Sie auf Seite 128. Bei zwei Ausgängen ist der Kabelsatz LOFD.0.B auf Seite 127 zu verwenden.  
 The matching cable kit for a single output (order no. LOZD.0.B) can be found on page 128. For two outputs use the cable kit LOFD.0.B on page 127.  
 Vous trouverez le jeu de câbles correspondant pour une sortie (N° d'article LOZD.0.B) à la page 128. En cas de deux sorties, utilisez le jeu de câbles LOFD.0.B de la page 127.

## 424 RD

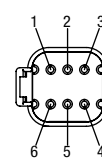

Den passenden Kabelsatz für einen Ausgang (Artikel-Nr L1ZD.0.B) finden Sie auf Seite 129. Bei zwei Ausgängen ist der Kabelsatz L1FD.0.B auf Seite 128 zu verwenden.  
 The matching cable kit for a single output (order no. L1ZD.0.B) can be found on page 129. For two outputs use the cable kit L1FD.0.B on page 128.  
 Vous trouverez le jeu de câbles correspondant pour une sortie (N° d'article L1ZD.0.B) à la page 129. En cas de deux sorties, utilisez le jeu de câbles L1FD.0.B de la page 128.

## 350 210 Betätigungshebel Actuating lever Levier de commande

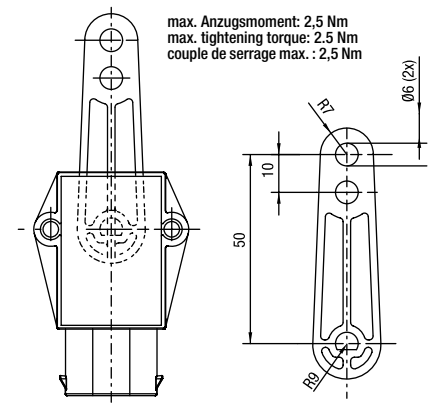
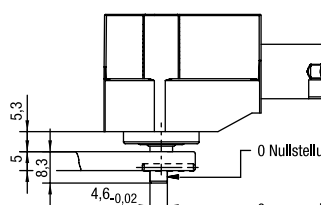
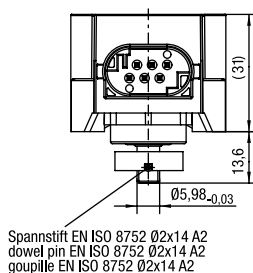

**424 R. ...**      **Bestellangaben**  
**Ordering information**  
**Page de sélection des spécifications**

**424 R**

<p>B = Betätigungshebel montiert  Z = Zentrierung ø18 ohne Abdeckkappe</p> <p><b>Winkelmessbereich</b>  3 Stellen (Wert = Winkel)  z.B. 030 = 30 Grad</p> <p><b>Ausgangssignal</b>  G = gegenläufig  P = parallel  K = nur Ausgang 1</p> <p><b>Ausgangssignal 2</b>  0 = 1–5 V  1 = 4–20 mA  2 = 4–20 mA/8,5 V  6 = 0,5–4,5 V ratiometrisch  7 = 0,5–4,5 V  K = kein Signal</p> <p><b>Ausgangssignal 1</b>  0 = 1–5 V  1 = 4–20 mA  2 = 4–20 mA/8,5 V  6 = 0,5–4,5 V ratiometrisch  7 = 0,5–4,5 V</p> <p><b>Lager</b>  0 = Gleitlager  1 = Kugellager</p> <p><b>Anschluss</b>  A = AMP-Stecker  Micro Quadlock 114-18063-21  Kodierung A  D = Deutsch-Stecker DT04-6P</p>	<p>B = actuating lever assembled  Z = centre ring ø18 without cap</p> <p><b>angular measuring range</b>  3 digits (value = angle)  e.g. 030 = 30 degree</p> <p><b>output signal</b>  G = reversed  P = parallel  K = only output 1</p> <p><b>output signal 2</b>  0 = 1–5 V  1 = 4–20 mA  2 = 4–20 mA/8,5 V  6 = 0,5–4,5 V ratiometric  7 = 0,5–4,5 V  K = no signal</p> <p><b>output signal 1</b>  0 = 1–5 V  1 = 4–20 mA  2 = 4–20 mA/8,5 V  6 = 0,5–4,5 V ratiometric  7 = 0,5–4,5 V</p> <p><b>bearing</b>  0 = plain bearing  1 = ball bearing</p> <p><b>connector</b>  A = AMP-connector  Micro Quadlock 114-18063-21  codification A  D = Deutsch connector DT04-6P</p>	<p>B = levier d'actionnement assemblé  Z = sortie d'axe ø18 sans capuchon</p> <p><b>plage de mesure angulaire</b>  3 positions (valeur = angle)  p.e. 030 = 30 degrés</p> <p><b>signal de sortie</b>  G = en opposition  P = en phase  K = 1 seule sortie</p> <p><b>signal de sortie 2</b>  0 = 1–5 V  1 = 4–20 mA  2 = 4–20 mA/8,5 V  6 = 0,5–4,5 V ratiométrique  7 = 0,5–4,5 V  K = sans signal</p> <p><b>signal de sortie 1</b>  0 = 1–5 V  1 = 4–20 mA  2 = 4–20 mA/8,5 V  6 = 0,5–4,5 V ratiométrique  7 = 0,5–4,5 V</p> <p><b>palier</b>  0 = palier  1 = roulement à billes</p> <p><b>connecteur</b>  A = connecteur AMP  Micro Quadlock 114-18063-21  codification A  D = connecteur Deutsch DT04-6P</p>
---	---	---

**Allgemeine Angaben**

Der Winkelmessbereich liegt zwischen 30° und 120°. Das Messprinzip ist kontaktlos, es basiert auf einem sich um einen Hallsensor drehenden Magnetfeld. Das System ist kurzschlussicher. Es gibt keinen mechanischen Anschlag.

**General information**

The angular measuring range is between 30° and 120°. The measuring principle is non-contacting (rotating magnetic field over hall-sensor). The system is short circuit-proof. There is no mechanical stop.

**Information générale**

La plage de mesure angulaire est entre 30° et 120°. Le principe de mesure est sans contact (champ magnétique tournant sur détecteur à effet Hall). Le système est protégé contre les courts circuits. La rotation mécanique de l'axe est illimitée.

**424 R ...**      **Winkelsensor mit optionalem 2. Ausgangssignal (redundant)**  
**mit AMP-Stecker (Micro Quadlock System) oder Deutsch-Stecker DT04-6P**  
**Angle sensor with optional 2. output (redundant)**  
**with AMP-connector (Micro Quadlock) or Deutsch-connector DT04-6P**  
**Détecteur angulaire avec 2. sorties optionnelles (redundant)**  
**avec connecteur AMP (Micro Quadlock) ou connecteur Deutsch DT04-6P**

Typen Nr. type no. référence	Betriebsspannung operating voltage tension d'alim.	Ausgangssignal 1 output signal 1 signal de sortie 1	Ausgangssignal 2 output signal 2 signal de sortie 2	Stromaufnahme current consumption consommation de courant	Auflösung resolution résolution	Lastwiderstand load resistance résistance de charge	Mittelstellung centre position zéro
424 R ..00.....	10 – 30 V DC	1 – 5 V	1 – 5 V	12 V → 18 mA	< 0,1°	> 20 kΩ	3 V
424 R ..11.....	10 – 30 V DC	4 – 20 mA	4 – 20 mA	12 V → 18 mA		*	12 mA
424 R ..22.....	8,5 V DC	4 – 20 mA	4 – 20 mA	8,5 V → 35 mA		200 Ω → GND	12 mA
424 R ..66.....	4,5 – 5,5 V DC	0,5 – 4,5 V ration.	0,5 – 4,5 V ration.	5 V → 8 mA		> 20 kΩ	typ. 2,5 V
424 R ..77.....	10 – 30 V DC	0,5 – 4,5 V	0,5 – 4,5 V	12 V → 10 mA		> 20 kΩ	typ. 2,5 V

\* bei Betriebsspannung/with operating voltage/avec une tension d'alim. de: 10 V < 250 Ω  
30 V < 1250 Ω

Typen Nr. type no. référence	Verpolschutz reverse connection protected protégé contre inversions de polarité	Verzögerungszeit des Ausgangssignals delay time of output signal temps de retardement signal de sortie	Temperaturbereich temperature range plage de température	Schutzart protection class protection
424 R ..00.....	ja/yes/oui	ca./approx./env. 3 ms	-40...+85°C	IP 67
424 R ..11.....				
424 R ..22.....				
424 R ..66.....				
424 R ..77.....				

Typische Werte für verschiedene Winkelbereiche (20°C) typical values for different angular ranges (20°C) valeurs typiques pour les plages de mesure angulaire (20°C)	±15°	±25°	±35°	±45°	±60°
typischer Linearitätsfehler (°) linearity error (°) erreur de linearité (°)	±0,2	±0,4	±1,0	±2,0	±5,0
Offset-Temperaturdrift (mV/°C) offset-temperature-drift (mV/°C) déviation offset-température (mV/°C)	1,1	0,3	0,4	0,2	0,5
Offset-Temperaturdrift (µA/°C) offset-temperature-drift (µA/°C) déviation offset-température (µA/°C)	4,4	1,2	1,6	0,8	2,0

# Winkelsensoren Angle sensors DéTECTEURS angulaires

SIL-  
capable  
EN61508

U<sub>B</sub>  
30 V

V<sub>out</sub>  
I<sub>out</sub>

360°

IP 67

www.elobau.com



## 424 D..... Winkelsensor 360° mit optionalem 2. Ausgang Angle sensor 360° with optional 2. output DéTECTEUR angulaire 360° avec 2. sorties optionnelles

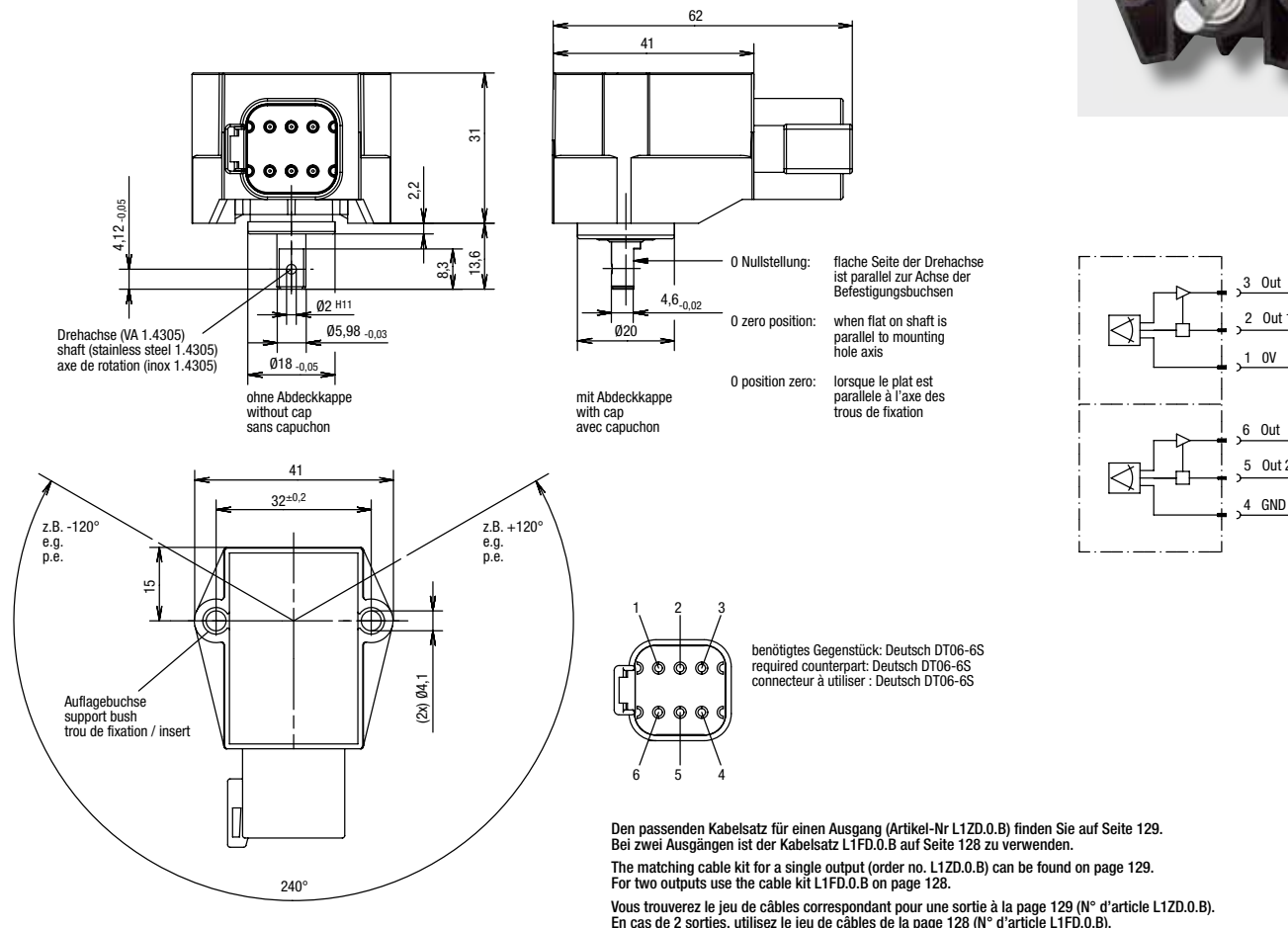

## 424 D..... Bestellangaben Ordering information Page de sélection des spécifications

424 D .....			
Betätigungshebel B = Hebel montiert Z = Zentrierung $\varnothing 18$ ohne Abdeckkappe	actuating lever B = lever assembled Z = centre ring 18 without cap	levier d'actionnement B = levier assemblé Z = centrage $\varnothing 18$ sans capuchon	
Winkelmessbereich 3 Stellen (Wert = Winkel) z.B. 270 = 270 Grad	angular measuring range 3 digits (value = angle) e.g. 270 = 270 degree	plage de mesure angulaire 3 positions (valeur = angle) p.e. 270 = 270 degrés	
Ausgangssignal 0 = 1-5 V 1 = 4-20 mA 7 = 0,5-4,5 V P = PWM (auf Anfrage)	output signal 0 = 1-5 V 1 = 4-20 mA 7 = 0,5-4,5 V P = PWM (on request)	signal de sortie 0 = 1-5 V 1 = 4-20 mA 7 = 0,5-4,5 V P = PWM (sur demande)	
1 = ein Ausgang (CCW)* 2 = zwei Ausgänge (CCW)* 3 = ein Ausgang (CW)* 4 = zwei Ausgänge (CW)* 5 = zwei Ausgänge (gegenläufiges Signal)	1 = one output (CCW)* 2 = two outputs (CCW)* 3 = one output (CW)* 4 = two outputs (CW)* 5 = two outputs (opposite signal)	1 = une sortie (CCW)* 2 = deux sorties (CCW)* 3 = une sortie (CW)* 4 = deux sorties (CW)* 5 = deux sorties (signal opposé)	

\* CW = clockwise,  
CCW = counter clockwise

**424 D.....**      **Winkelsensor 360° mit optionalem 2. Ausgang**  
**Angle sensor 360° with optional 2. output**  
**Détecteur angulaire 360° avec 2. sorties optionnelles**

**Allgemeine Angaben**

Der Winkelmessbereich liegt zwischen 20° und 359°. Das Messprinzip ist kontaktlos, es basiert auf einem sich über dem 2D Hall-sensor drehenden Magnetfeld. Das System ist kurzschlussicher. Es gibt keinen mechanischen Anschlag. EMV-fest für Kfz-Bereich (DIN 40839; Prüfpuls 1, 2, 3a/b; Feldeinstreuung 200 V/m). Gehäusematerial: PBT.

**General information**

The angular measuring range is between 20° and 359°. The measuring principle is non-contacting (rotating magnetic field over 2D hall-sensor). The system is short circuit-proof. There is no mechanical stop. EMC standards for motor industry (DIN 40839; testing impulses 1, 2, 3a/b; interference immunity 200 V/m). Housing material: PBT.

**Information générale**

La plage de mesure angulaire est entre 20° et 359°. Le principe de mesure est sans contact (champ magnétique tournant sur détecteur à effet Hall 2D). Le système est protégé contre les courts circuits. La rotation mécanique de l'axe est illimitée. Directives CEM pour l'industrie automobile (DIN 40839; impulsion de test 1, 2, 3a/b; immunité aux interférences 200 V/m). Matériau du boîtier: PBT.

Typen Nr. type no. référence	Betriebsspannung operating voltage tension d'alimentation	Ausgangssignal output signal signal de sortie	Stromaufnahme current consumption consommation de courant	Lastwiderstand load resistance résistance de charge	Mittelstellung centre position zéro
424 D.0....	10–30 V DC	1–5 V (Ri = 1 kΩ)	< 30 mA	≥ 100 kΩ *	typ. 3 V
424 D.1....		4–20 mA		UB > 15 V max. 500 Ω UB < 15 V max. 200 Ω	12 mA
424 D.7....		0,5–4,5 V (Ri = 1 kΩ)		≥ 100 kΩ *	typ. 2,5 V

Typen Nr. type no. référence	Verpolschutz reverse connection protected protégé contre inversions de polarité	Signalaktualisierungsrate signal update rate taux d'acquisition de la mesure	Temperaturbereich temperature range plage de température	Schutzart protection class protection
424 D.0....	ja/yes/oui	≥ 1,6 kHz	-40...+85°C	IP 67
424 D.1....				
424 D.7....				

\* empfohlen / recommended / recommandé

**Idealer Signalverlauf**  
**Ideal signal course**  
**Signal idéal**

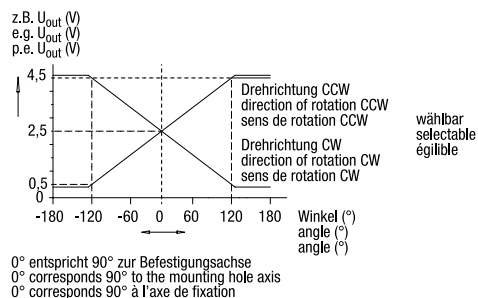

	vom Winkelbereich of the angular range de la plage de mesure angulaire
<b>Auflösung</b> resolution résolution	12 Bit
<b>Linearitätsfehler (°)</b> linearity error (°) erreur de linéarité (°)	< ± 1%
<b>Temperaturdrift</b> temperature-drift déviation température	< ± 1,2%



# Winkelsensoren Angle sensors DéTECTEURS angulaires

## 424 C.360 CAN-Winkelsensor 360° CAN-angle sensor 360° DéTECTEUR angulaire CAN 360°

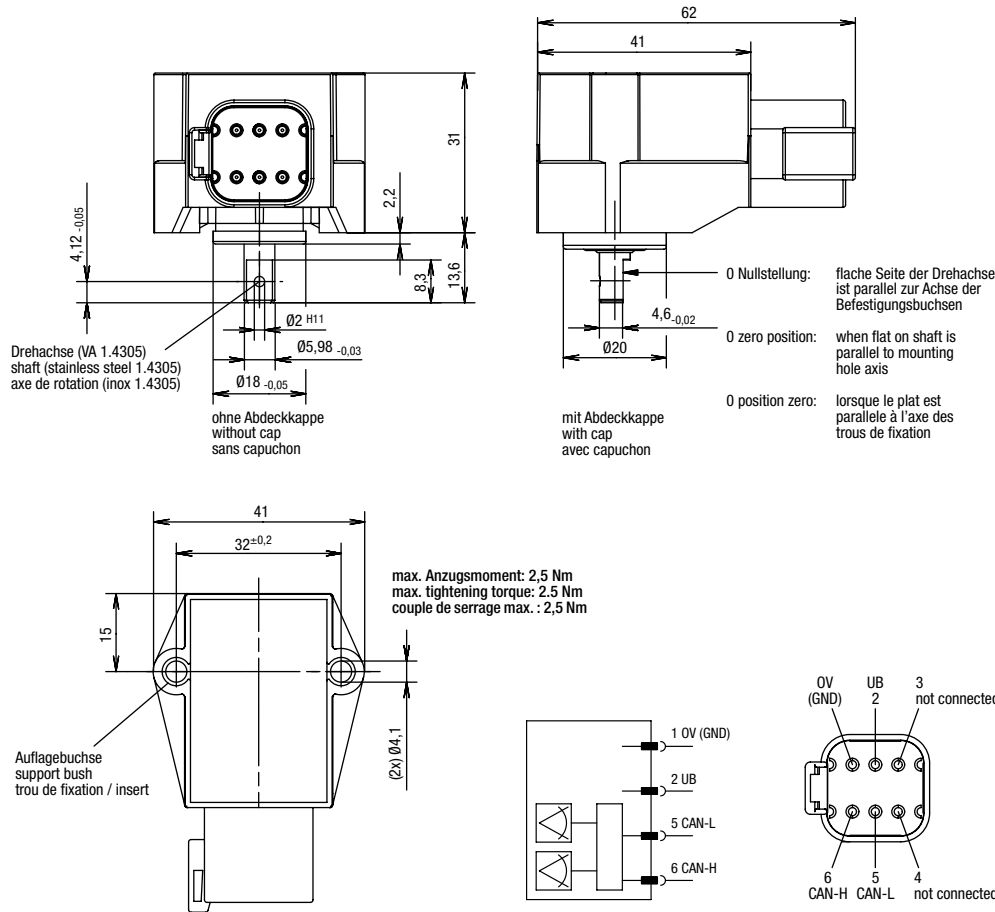

Typen Nr. type no. référence	Betriebsspannung operating voltage tension d'alim.	Stromaufnahme current consumption consommation de courant	Schutzart protection class protection	Temperaturbereich temperature range plage de température
424 C0360	+9...+32 VDC	max. 70 mA	IP 67 (DIN EN 60529)	-40°C...+85°C
424 CJ360				

Typen Nr. type no. référence	CAN CAN CAN	Protokoll protocol protocole	Abschlusswiderstand terminating resistor résistance de charge	Baudrate baudrate taux de transmission	Sendezyklus cycle time temps de cycle
424 C0360	ISO 11898, CAN specification 2.0B	CANopen	nein / no / non	250 kbit/s	100 ms
424 CJ360					

Typen Nr. type no. référence	Winkel 1 angle 1 angle 1	Winkel 2 angle 2 angle 2	Auflösung resolution résolution	Linearitätsfehler linearity error erreur de linearité	Temperaturdrift temperature-drift déviation température	EMV-Festigkeit EMC standards Directives CEM
424 C0360	CW	CCW	0,1° / Bit	< ± 1%	< 0,002° / °C	Feldeinstreuung 200 V/m
424 CJ360						

Kabelsätze siehe S. 128 (L1FD.0.B)  
Cable sets see p. 128 (L1FD.0.B)  
Câbles associés voir p. 128 (L1FD.0.B)

Änderungen und Irrtümer bleiben vorbehalten. Abbildungen ähnlich. Maßgeblich sind die dem ausgelieferten Produkt beigelegten technischen Dokumentationen.  
The relevant corresponding technical documents will be supplied with the product. Certain product descriptions can be similar therefore please ensure that you have the latest version of documentation for your specific product prior to any use. elobau reserves the right to change technical data and documentation without notice.  
Sous réserve de modifications et d'erreurs. Images similaires. Les documentations techniques accompagnant les produits sont d'application.



Wir produzieren klimaneutral.  
We produce in a carbon-neutral manner.  
Nous produisons avec un bilan carbone neutre.

**424 C.360**      **Bestellangaben**  
**Ordering information**  
**Page de sélection des spécifications**

<b>424 C</b> . . . . .	<b>Betätigungshebel</b> B = Hebel montiert Z = Zentrierung Ø18 ohne Abdeckkappe	<b>actuating lever</b> B = lever assembled Z = centre ring 18 without cap	<b>levier d'actionnement</b> B = levier assemblé Z = centrage Ø18 sans capuchon
	<b>Winkelmessbereich</b> 3 Stellen (Wert = Winkel) z.B. 030 = 30 Grad	<b>angular measuring range</b> 3 digits (value = angle) e.g. 030 = 30 degree	<b>plage de mesure angulaire</b> 3 positions (valeur = angle) p.e. 030 = 30 degrés
	<b>CAN Protokoll</b> 0 = CANopen J = 1939	<b>CAN protocol</b> 0 = CANopen J = 1939	<b>CAN protocole</b> 0 = CANopen J = 1939

# Winkelsensoren Angle sensors DéTECTEURS angulaires

## 424 Z....

Winkelsensor axial  
Axial angle sensor  
DéTECTEUR angulaire axial

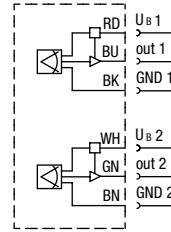
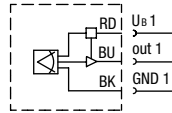
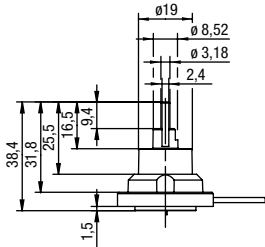
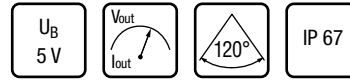

z.B. 120° / e.g. 120° / p.e. 120°

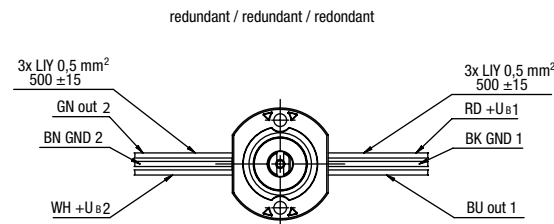
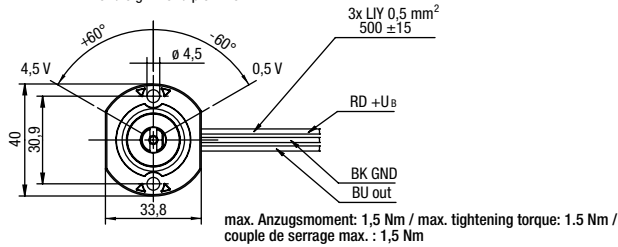

Typen Nr. type no. référence	Betriebsspannung operating voltage tension d'alim.	Ausgangssignal output signal signal de sortie	Stromaufnahme current consumption consommation de courant	Winkelbereich measuring range plage de mesure	Lastwiderstand load resistance résistance de charge	Mittelstellung centre position zéro
424 Z....	5 V DC ± 0,5	0,5...4,5 V	5 V → 10 mA	± 60°	> 10 kΩ	3 V

Typen Nr. type no. référence	Verpolschutz reverse polarity protected protégé contre inversions de polarité	Verzögerungszeit des Ausgangssignals delay time of output signal temps de retardement signal de sortie	Temperaturbereich temperature range plage de température	Schutzart protection class protection	Auflösung resolution résolution	Kabel cable câbles
424 Z....	ja/yes/oui	ca./approx./env. 3 ms	-40...+85°C	IP 67	0,1°	PVC, 0,5 m ± 15 mm, 0,5 mm²

## 424 Z . . . .

Winkelmessbereich  
3 Stellen: Wert = Winkel  
z.B.: 030 = 30 Grad

E = Ausgang 1  
P = parallel  
G = gegenläufig

angular measuring range  
3 digits: value = angle  
e.g.: 030 = 30 degree

E = output 1  
P = parallel  
G = counterrotare

plage de mesure angulaire  
3 positions: valeur = angle  
p.e.: 030 = 30 degrés

E = sortie 1  
P = parallèle  
G = opposé

### Allgemeine Angaben

Der Winkelbereich liegt zwischen 30° und 120°. Das Messprinzip ist kontaktlos, es basiert auf einem sich um einen Hallsensor drehendes Magnetfeld. Das System ist kurzschlussicher. Der mechanische Anschlag liegt etwa bei 180°. Die Drehachse ist in Kunststoff gelagert. Es darf daher keine Kraft auf die Drehachse wirken, d.h. jegliche Hebel sind nicht zulässig.

### General information

The angular measuring range is between 30° and 120°. The measuring principle is noncontacting (rotating magnetic field over hallsensor). The system is short circuit-proof. There is a mechanical stop at approx. 180°. The rotary axle is in a plastic bearing. Therefore, no radial force must be applied on the shaft (no actuating levers are permitted).

### Information générale

La plage de mesure angulaire est entre 30° et 120°. Le principe de mesure est sans contact (champ magnétique tournant sur détecteur à effet Hall). Le système est protégé contre les courts circuits. La rotation mécanique de l'axe est limité à 180°. Le détecteur est conforme aux directives. L'axe de rotation est logé dans un revêtement plastique. Par conséquent, aucune force ne doit être exercée sur l'axe de rotation; l'utilisation de leviers n'est pas autorisée.



# 7

## Neigungssensoren Tilt switches Capteur de dévers



Neigungssensoren – einachsig  
Tilt switch – single axis  
Capteur de dévers – un axe

99...102



Neigungssensoren – zweiachsig  
Tilt switch – two axis  
Capteur de dévers – deux axes

103...106



Winkelanzeige  
Angle instrument  
Affichage angulaire

107





# Neigungssensor Tilt sensor Capteurs de dévers

N 3.....

Neigungssensor – einachsig, horizontal  
Tilt sensor – single axis, horizontal  
Capteurs de dévers – un axe, horizontal

SIL-  
capable  
EN61508

$U_B$   
30 V

$V_{out}$   
out

120°

IP 67



X-Achse  
X axis  
axe X

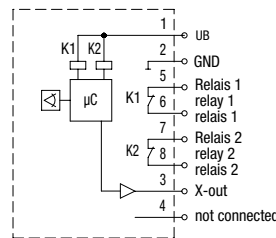
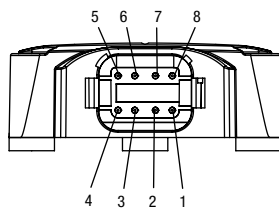
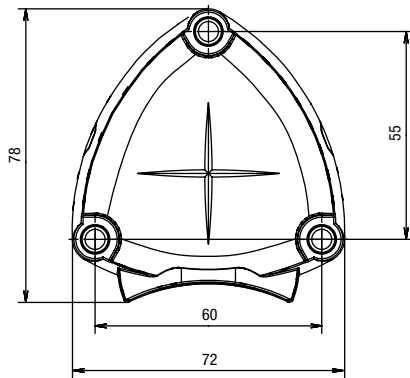
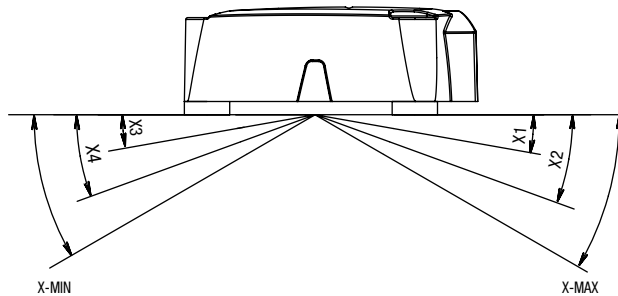
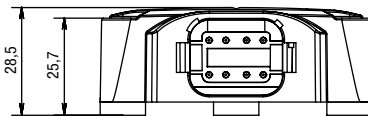

Achtung: Bei der horizontalen Montage können Neigungen nur auf der x-Achse gemessen werden.  
Attention: With the horizontal installation you are able to measure tilts on the x-axis only.  
Attention: paramétrage de la mesure sur l'axe X ou Y en usine

Blockschaltbild abgebildet mit angelegter Betriebsspannung in Nulllage.  
Block circuit diagram shown with operating voltage in zero position.  
circuit représenté capteur alimenté et dévers zéro.

Den passenden Kabelsatz finden Sie auf Seite 129 (L1HC00.B).  
The matching cable kit can be found on page 129 (L1HC00.B).  
Vous trouverez le jeu de câbles correspondant à la page 129 (L1HC00.B).

## Infrarot Fernbedienung zur Null-Lage-Justierung IR-NGS01 Infrared remote control for neutral position adjustment IR-NGS01 Télécommande à infrarouge pour l'ajustement de la position zéro IR-NGS01

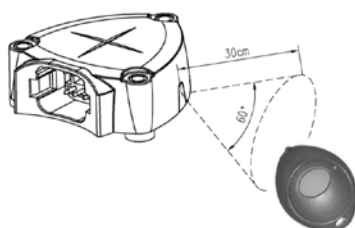

Alle Neigungssensoren sind mit einer Null-Lage vorprogrammiert. Bei Bedarf kann ein Abgleich der Null-Lage mit einer Infrarot-Fernbedienung vorgenommen werden. Bei diesem Abgleich wird der momentane Neigungswinkel als Null-Lage definiert.

All tilt sensors are preprogrammed with a neutral position. If required, the neutral position can be adjusted using an infrared remote control. During this adjustment, the current inclination angle is defined as the neutral position.

Tous les capteurs de dévers sont préprogrammés avec une position zéro. En cas de besoin, il est possible de calibrer la position zéro à l'aide d'une télécommande à infrarouge. Ce calibrage définit l'angle de mesure actuel comme position zéro.

# Neigungssensor Tilt sensor Capteurs de dévers

## N 3..... Neigungssensor – einachsig, vertikal Tilt sensor – single axis, vertical Capteurs de dévers – un axe, vertical

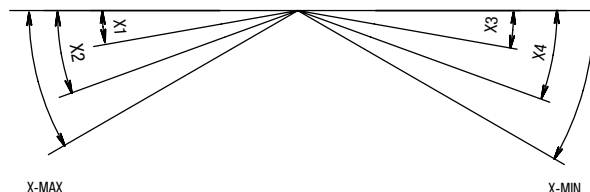
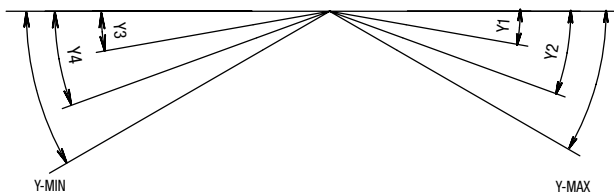
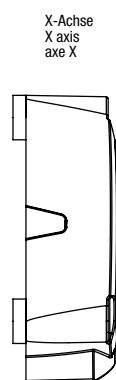
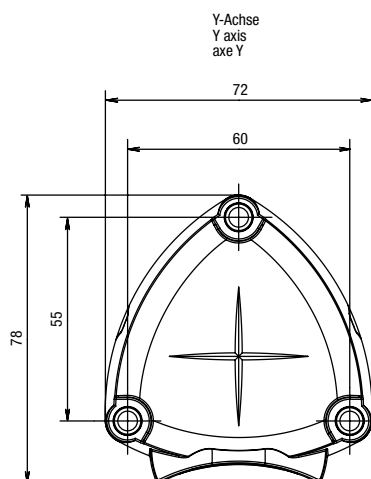
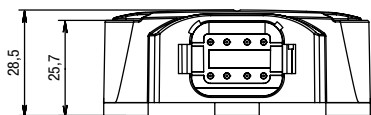

**Achtung:** Bei der vertikalen Montage kann die messende Achse auf die X- oder Y-Achse festgelegt werden.  
**Attention:** The measuring Axis could be on the X- or Y-Axis by the vertical mounting.  
**Attention:** paramétrage de la mesure sur l'axe X ou Y en usine

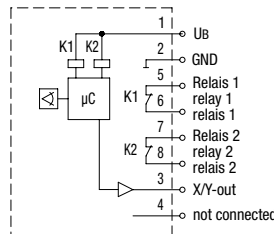
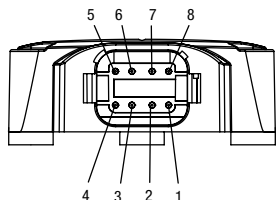

Blockschaltbild abgebildet mit angelegter Betriebsspannung in Nulllage.  
Block circuit diagram shown with operating voltage in zero position.  
circuit représenté capteur alimenté et dévers zéro.

Den passenden Kabelsatz finden Sie auf Seite 129 (L1HC00.B).  
The matching cable kit can be found on page 129 (L1HC00.B).  
Vous trouverez le jeu de câbles correspondant à la page 129 (L1HC00.B).



**N3**

<p><b>Zählnummern</b> (wird von elobau vergeben)</p> <p><b>Ausschalt-Verzögerungszeit (Schaltausgang) *</b> A = keine Verzögerung B = 0,5 s C = 1 s D = 1,5 s E = 2 s</p> <p><b>Einschalt-Verzögerungszeit (Schaltausgang) *</b> A = keine Verzögerung B = 0,5 s C = 1 s D = 1,5 s E = 2 s</p> <p><b>Verknüpfungsart (Schaltausgang) *</b> <b>X- oder Y-Achse</b> 4 = Relais 1 = X1/X3     Relais 2 = X2/X4 5 = Relais 1 = X1/X3 6 = Relais 1 = X1     Relais 2 = X3 7 = Relais 1 = Y1/Y3 8 = Relais 1 = Y1/Y3     Relais 2 = Y2/Y4 9 = Relais 1 = Y1     Relais 2 = Y3</p> <p><b>Relais (Schaltausgang) *</b> A = 1 x Relais (Öffner) B = 2 x Relais (Öffner) C = 1 x Relais (Schließer) D = 2 x Relais (Schließer)</p> <p><b>analoges Ausgangssignal</b> 0 = kein Signal 1 = 4–20 mA 2 = 0,5–4,5 V</p> <p><b>Ausgänge</b> A = analog D = Schaltausgang K = kombiniert (analog+Schaltausgang)</p> <p><b>Gehäuse / Montage</b> A = horizontal (Deutsch 8-pol.) B = vertikal X-Achse (Deutsch 8-pol.) C = horizontal (Kabel) D = vertikal X-Achse (Kabel) E = vertikal Y-Achse (Deutsch 8-pol.) F = vertikal Y-Achse (Kabel)</p>	<p><b>counting numbers</b> (issued by elobau)</p> <p><b>switch-off delay time (discrete output definition) *</b> A = no delay time B = 0,5 s C = 1 s D = 1,5 s E = 2 s</p> <p><b>switch-on delay time (discrete output definition) *</b> A = no delay time B = 0,5 s C = 1 s D = 1,5 s E = 2 s</p> <p><b>type of link (discrete output definition) *</b> <b>X- or Y-axis</b> 4 = relay 1 = X1/X3     relay 2 = X2/X4 5 = relay 1 = X1/X3 6 = relay 1 = X1     relay 2 = X3 7 = relay 1 = Y1/Y3 8 = relay 1 = Y1/Y3     relay 2 = Y2/Y4 9 = relay 1 = Y1     relay 2 = Y3</p> <p><b>relays (discrete output definition) *</b> A = 1 x relay (N.C.) B = 2 x relay (N.C.) C = 1 x relay (N.O.) D = 2 x relay (N.O.)</p> <p><b>analogue output signal</b> 0 = no signal 1 = 4–20 mA 2 = 0,5–4,5 V</p> <p><b>outputs</b> A = analogue D = discrete output K = combined (analogue+discrete output)</p> <p><b>housing / mounting</b> A = horizontal (Deutsch 8-pol.) B = vertical X-axis (Deutsch 8-pol.) C = horizontal (cable) D = vertical X-axis (cable) E = vertical Y-axis (Deutsch 8-pol.) F = vertical Y-axis (cable)</p>	<p><b>numéros d'article</b> (adjuger à elobau)</p> <p><b>temporisation à la désactivation (sortie TOR) *</b> A = sans temporisation B = 0,5 s C = 1 s D = 1,5 s E = 2 s</p> <p><b>temporisation à l'activation (sortie TOR) *</b> A = sans temporisation B = 0,5 s C = 1 s D = 1,5 s E = 2 s</p> <p><b>type de liaison (sortie TOR) *</b> <b>X- ou Y-axe</b> 4 = relais 1 = X1/X3     relais 2 = X2/X4 5 = relais 1 = X1/X3 6 = relais 1 = X1     relais 1 = X3 7 = relais 1 = Y1/Y3 8 = relais 1 = X1/X3     relais 2 = Y2/Y4 9 = relais 1 = Y1     relais 1 = Y3</p> <p><b>relais (sortie TOR) *</b> A = 1 x relais (NF) B = 2 x relais (NF) C = 1 x relais (NO) D = 2 x relais (NO)</p> <p><b>signal de sortie analogique</b> 0 = aucun signal 1 = 4–20 mA 2 = 0,5–4,5 V</p> <p><b>sortie</b> A = analogique D = sortie TOR K = combiné (analogique+sortie TOR)</p> <p><b>boîtier / montage</b> A = horizontal (Deutsch 8-pol.) B = vertical X-axe (Deutsch 8-pol.) C = horizontal (câble) D = vertical X-axe (câble) E = vertical Y-axe (Deutsch 8-pol.) F = vertical Y-axe (câble)</p>
---	--	---

\* Entfällt bei Auswahl analog / not applicable with selection analogue / non disponible en cas de sélection analogique

<p>Winkelbereich für analoges Ausgangssignal angle range for analogue output signal plage d'angle pour signal de sortie analogique</p>	<p>Schaltpunkte für Schaltausgänge switching points for discrete outputs points de commut. pour sortie TOR</p>
<p><b>Winkelbereich:</b> .....° (±5° ... ±60°) <b>angle range:</b> .....° (±5° ... ±60°) <b>plage angulaire:</b> .....° (±5° ... ±60°)</p>	<p><b>Schaltpunkte (±1,5° ... ±60°):</b> <b>switching points (±1,5° ... ±60°):</b> <b>points de commutation (±1,5° ... ±60°):</b> + X1 .....°                      oder                      + Y1 .....° + X2 .....°                      or                      + Y2 .....° - X3 .....°                      ou bien                      - Y3 .....° - X4 .....°                      - Y4 .....°</p>

**N 3.....**      **Allgemeine Daten**  
**General information**  
**Informations générales**

	analoges Ausgangssignal analogue output signal signal de sortie analogique	Schaltausgang discrete output sortie TOR
Neigungswinkel / angular range / plage de mesure	$\pm 5^\circ \dots \pm 60^\circ$	$\pm 1,5^\circ \dots \pm 60^\circ$
Betriebsspannung / supply / alimentation	10...30 VDC	10 ... 30V DC*
Betriebsstrom / operating current / courant de service	typ. 24 mA	typ. 24 mA typ. zusätzlich 12 mA pro Relais typ. additionally 12 mA per relais typ. 12mA par relais additionnel
Ausgangssignal / output signal / signal de sortie	$U_{out} = 0,5 V \dots 4,5 V$ $I_{out} = 4 mA \dots 20 mA$	Relais / relay / relais
Lastwiderstand (RL) load resistance (RL) résistance de charge (RL)	$U_{out} = \text{min. } 10 \text{ k}\Omega (R_i = 100 \Omega)$ $I_{out} = UB > 15 V \text{ max. } 500 \Omega$ $UB < 15 V \text{ max. } 200 \Omega$	–
Schaltspannung / switching voltage / tension de commutation	–	max. 48 VDC
Schaltstrom / switching current / courant de commutation	–	max. 1 A / 30 W / 30 VA
Verzögerungszeit / delay time / temps de retardement	–	wählbar / selectable / éligible
Schaltpunkte / switching points / points de commutation	–	wählbar / selectable / éligible
Nullpunktjustierung mit Infrarotfernbedienung / zero justification with infrared remote control / ajustement du zéro avec télécommande infrarouge	max. $\pm 5^\circ$	max. $\pm 5^\circ$
Auflösung / resolution / résolution	Neigungswinkel / angular range / plage de mesure $\leq 25^\circ$ : $\leq 0,04^\circ$ Neigungswinkel / angular range / plage de mesure $> 25^\circ$ : $\leq 0,14^\circ$	
Linearitätsfehler linearity error erreur de linearité	typ. $\pm 1\%$ vom Winkelbereich typ. $\pm 1\%$ of the angular range typ. $\pm 1\%$ de la plage d'inclinaison	
Wiederholgenauigkeit repeating accuracy précision de répétition	Neigungswinkel / angular range / plage de mesure $\leq 25^\circ$ : $0,2^\circ$ Neigungswinkel / angular range / plage de mesure $> 25^\circ$ : $0,5^\circ$	
Temperaturdrift offset temperature drift déviation offset-température	$\pm 0,25\%$ (Spannungsausgang / voltage output / sortie tension 0,5V ... 4,5V) $\pm 1\%$ (Stromausgang / current output / sortie courant 4mA ... 20mA)	
Vibrationsfilter vibration filter filtrage des vibrations	Grenzfrequenz typ. 40 Hz (auf Kundenwunsch veränderbar) critical frequency typ. 40 Hz (adjustable upon customer request) fréquence critique typ. 40 Hz (modifiable sur demande client)	
Signalaktualisierungsrate / signal update rate Vitesse de renouvellement du signal	ca. 100 Hz / appr. 100 Hz / env. 100 Hz	
Start-Up-Time / startup time / vitesse de démarrage	$\leq 500 \text{ ms}$	
Gehäusematerial housing material matériau du boîtier	Gehäuseoberteil: PBT GF35, Gehäusedeckel: PC top housing: PBT GF35, housing cover: PC partie sup. du boîtier: PBT GF35, couvercle du boîtier: PC	
Montagebuchse / mounting bush / douille de montage	$\varnothing 5,3 \text{ mm}$	
Temperaturbereich / temperature range / plage de température	$-40^\circ\text{C} \dots +70^\circ\text{C}$	
Schutzart / protection class / protection	IP 67 DIN EN 60529	

\* Toleranzangabe bei RT 23°C. Für andere Temperaturen gilt:  $U_{bmin} = T_{amb} * 0,0344 + 9V$ ; tolerance details at room temperature 23°C. applies to other temperatures:  $U_{bmin} = T_{amb} * 0,0344 + 9V$ ;  
 Plage de tension à T 23°C. Pour d'autres températures :  $U_{bmin} = T_{amb} * 0,0344 + 9V$

# Neigungssensor Tilt sensor Capteurs de dévers

N 4.....

Neigungssensor – zweiachsig, horizontal  
Tilt sensor – two axis, horizontal  
Capteurs de dévers – deux axes, horizontal

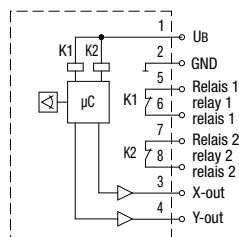
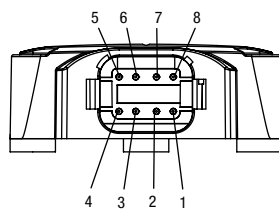
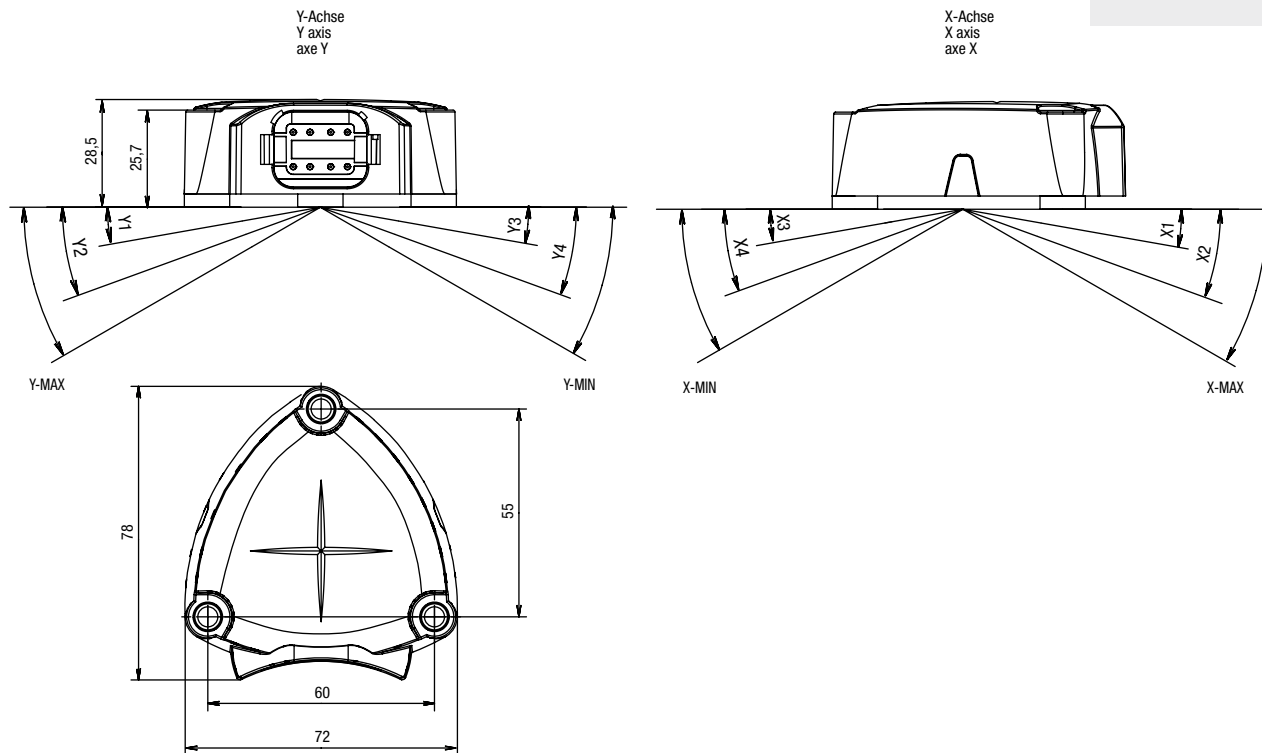
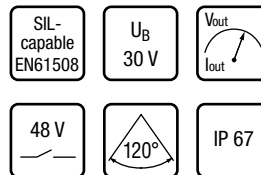

Blockschaltbild abgebildet mit angelegter Betriebsspannung in Nulllage.  
Block circuit diagram shown with operating voltage in zero position.  
circuit représenté capteur alimenté et dévers zéro.

Den passenden Kabelsatz finden Sie auf Seite 129 (L1HC00.B).  
The matching cable kit can be found on page 129 (L1HC00.B).  
Vous trouverez le jeu de câbles correspondant à la page 129 (L1HC00.B).

## Infrarot Fernbedienung zur Null-Lage-Justierung IR-NGS01 Infrared remote control for neutral position adjustment IR-NGS01 Télécommande à infrarouge pour l'ajustement de la position zéro IR-NGS01

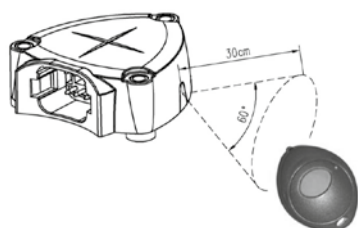

Alle Neigungssensoren sind mit einer Null-Lage vorprogrammiert. Bei Bedarf kann ein Abgleich der Null-Lage mit einer Infrarot-Fernbedienung vorgenommen werden. Bei diesem Abgleich wird der momentane Neigungswinkel als Null-Lage definiert.

All tilt sensors are preprogrammed with a neutral position. If required, the neutral position can be adjusted using an infrared remote control. During this adjustment, the current inclination angle is defined as the neutral position.

Tous les capteurs de dévers sont préprogrammés avec une position zéro. En cas de besoin, il est possible de calibrer la position zéro à l'aide d'une télécommande à infrarouge. Ce calibrage définit l'angle de mesure actuel comme position zéro.

# Neigungssensor Tilt sensor Capteurs de dévers

**N 4.....** Neigungssensor – zweiachsig, vertikal  
Tilt sensor – two axis, vertical  
Capteurs de dévers – deux axes, vertical

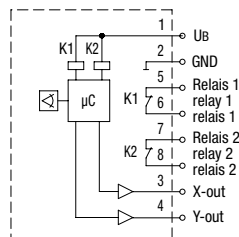
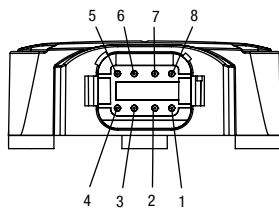
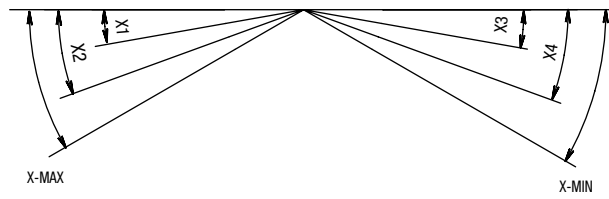
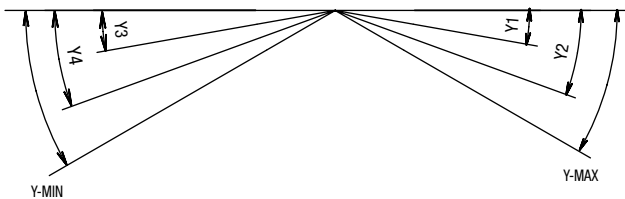
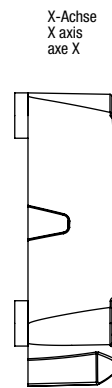
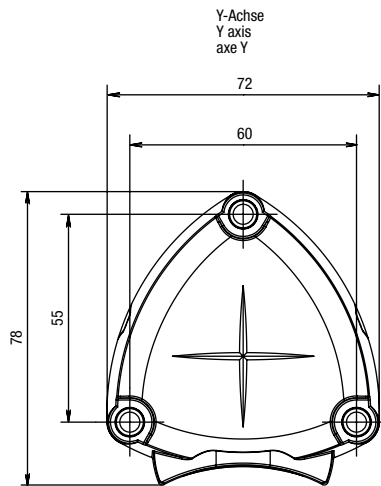
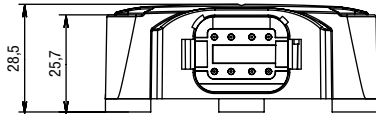

Blockschaltbild abgebildet mit angelegter Betriebsspannung in Nulllage.  
Block circuit diagram shown with operating voltage in zero position.  
circuit représenté capteur alimenté et dévers zéro.

Den passenden Kabelsatz finden Sie auf Seite 129 (L1HC00.B).  
The matching cable kit can be found on page 129 (L1HC00.B).  
Vous trouverez le jeu de câbles correspondant à la page 129 (L1HC00.B).

**N4**

<b>Zählnummern</b> (wird von elobau vergeben)	<b>counting numbers</b> (issued by elobau)	<b>numéros d'article</b> (adjudger à elobau)
<b>Ausschalt-Verzögerungszeit (Schaltausgang) *</b> A = keine Verzögerung B = 0,5 s C = 1 s D = 1,5 s E = 2 s	<b>switch-off delay time (discrete output definition) *</b> A = no delay time B = 0,5 s C = 1 s D = 1,5 s E = 2 s	<b>temporisation à la désactivation (sortie TOR) *</b> A = sans temporisation B = 0,5 s C = 1 s D = 1,5 s E = 2 s
<b>Einschalt-Verzögerungszeit (Schaltausgang) *</b> A = keine Verzögerung B = 0,5 s C = 1 s D = 1,5 s E = 2 s	<b>switch-on delay time (discrete output definition) *</b> A = no delay time B = 0,5 s C = 1 s D = 1,5 s E = 2 s	<b>temporisation à l'activation (sortie TOR) *</b> A = sans temporisation B = 0,5 s C = 1 s D = 1,5 s E = 2 s
<b>Verknüpfungsart (Schaltausgang) * X- oder Y-Achse</b> 1 = Relais 1 = X1/X3 Y1/Y3 2 = Relais 1 = X1/X3 Relais 2 = Y1/Y3 3 = Relais 1 = X1/X3 Y1/Y3 Relais 2 = X2/X4 Y2/Y4 4 = Relais 1 = X1/X3 Relais 2 = X2/X4	<b>type of link (discrete output definition) * X- or Y-axis</b> 1 = relay 1 = X1/X3 Y1/Y3 2 = relay 1 = X1/X3 relay 2 = Y1/Y3 3 = relay 1 = X1/X3 Y1/Y3 relay 2 = X2/X4 Y2/Y4 4 = relay 1 = X1/X3 relay 2 = X2/X4	<b>type de liaison (sortie TOR) * X- ou Y-axe</b> 1 = relais 1 = X1/X3 Y1/Y3 2 = relais 1 = X1/X3 relais 2 = Y1/Y3 3 = relais 1 = X1/X3 Y1/Y3 relais 1 = X2/X4 Y2/Y4 4 = relais 1 = X1/X3 relais 2 = X2/X4
<b>Relais (Schaltausgang) *</b> A = 1 x Relais (Öffner) B = 2 x Relais (Öffner) C = 1 x Relais (Schließer) D = 2 x Relais (Schließer)	<b>relays (discrete output definition) *</b> A = 1 x relay (N.C.) B = 2 x relay (N.C.) C = 1 x relay (N.O.) D = 2 x relay (N.O.)	<b>relais (sortie TOR) *</b> A = 1 x relais (NF) B = 2 x relais (NF) C = 1 x relais (NO) D = 2 x relais (NO)
<b>Ausgangssignal X/Y Achse (analog)</b> 0 = kein Signal 1 = 4–20 mA 2 = 0,5–4,5 V	<b>output signal X/Y axis (analogue)</b> 0 = no signal 1 = 4–20 mA 2 = 0,5–4,5 V	<b>signal de sortie analogique</b> 0 = aucun signal 1 = 4–20 mA 2 = 0,5–4,5 V
<b>Ausgänge</b> A = analog D = Schaltausgang K = kombiniert (analog+Schaltausgang)	<b>outputs</b> A = analogue D = discrete output K = combined (analogue+discrete output)	<b>sortie</b> A = analogique D = sortie TOR K = combiné (analogique+sortie TOR)
<b>Gehäuse / Montage</b> A = horizontal (Deutsch 8-pol.) B = vertikal (Deutsch 8-pol.) C = horizontal (Kabel) D = vertikal (Kabel)	<b>housing / mounting</b> A = horizontal (Deutsch 8-pol.) B = vertical (Deutsch 8-pol.) C = horizontal (cable) D = vertical (cable)	<b>boîtier / montage</b> A = horizontal (Deutsch 8-pol.) B = vertical (Deutsch 8-pol.) C = horizontal (câble) D = vertical (câble)

\* Entfällt bei Auswahl analog / not applicable with selection analogue / non disponible en cas de sélection analogique

<b>Winkelbereich für analoges Ausgangssignal</b> angle range for analogue output signal plage d'angle pour signal de sortie analogique	<b>Schaltpunkte für Schaltausgänge</b> switching points for discrete outputs points de commut. pour sortie TOR
<b>Winkelbereich X-Achse:</b> .....° (±5° ... ±60°) <b>angle range X-axis:</b> .....° (±5° ... ±60°) <b>plage angulaire X-axe:</b> .....° (±5° ... ±60°)	<b>Schaltpunkte (±1,5° ... ±60°):</b> <b>switching points (±1,5° ... ±60°):</b> <b>points de commutation (±1,5° ... ±60°):</b> + X1 .....° + Y1 .....° + X2 .....° oder + Y2 .....° - X3 .....° or - Y3 .....° - X4 .....° ou bien - Y4 .....°
<b>Winkelbereich Y-Achse:</b> .....° (±5° ... ±60°) <b>angle range Y-axis:</b> .....° (±5° ... ±60°) <b>plage angulaire Y-axe:</b> .....° (±5° ... ±60°)	

**N 4.....**      **Allgemeine Daten**  
**General information**  
**Informations générales**

	analoges Ausgangssignal analogue output signal signal de sortie analogique	Schaltausgangssignal discrete output signal signal de sortie TOR
Neigungswinkel / angular range / plage de mesure	± 5°... ± 60°	± 1,5°... ± 60°
Betriebsspannung / supply / alimentation	10...30 VDC	10 ... 30V DC*
Betriebsstrom / operating current / courant de service	typ. 32 mA	typ. 32 mA typ. zusätzlich 12 mA pro Relais typ. additionally 12 mA per relais typ. 12 mA par relais additionnel
Ausgangssignal / output signal / signal de sortie	$U_{out} = 0,5 V \dots 4,5 V$ $I_{out} = 4 mA \dots 20 mA$	Relais / relay / relais
Lastwiderstand (RL) load resistance (RL) résistance de charge (RL)	$U_{out} = \text{min. } 10 \text{ k}\Omega \text{ (} R_i = 100 \Omega \text{)}$ $I_{out} = UB > 15 V \text{ max. } 500 \Omega$ $UB < 15 V \text{ max. } 200 \Omega$	–
Schaltspannung / switching voltage / tension de commutation	–	max. 48 VDC
Schaltstrom / switching current / courant de commutation	–	max. 1 A / 30 W / 30 VA
Verzögerungszeit / delay time / temps de retardement	–	wählbar / selectable / éligible
Schaltpunkte / switching points / points de commutation	–	wählbar / selectable / éligible
Nullpunktjustierung mit Infrarotfernbedienung / zero justification with infrared remote control / ajustement du zéro avec télécommande infrarouge	max. ± 5°	max. ± 5°
Auflösung / resolution / résolution	Neigungswinkel / angular range / plage de mesure ≤ 25°: ≤ 0,04° Neigungswinkel / angular range / plage de mesure > 25°: ≤ 0,14°	
Linearitätsfehler linearity error erreur de linearité	typ. ± 1% vom Winkelbereich typ. ± 1% of the angular range typ. ± 1% de la plage d'inclinaison	
Wiederholgenauigkeit repeating accuracy précision de répétition	Neigungswinkel / angular range / plage de mesure ≤ 25°: 0,2° Neigungswinkel / angular range / plage de mesure > 25°: 0,5°	
Temperaturdrift offset temperature drift déviaton offset-température	± 0,25 % (Spannungsausgang / voltage output / sortie tension 0,5 V ... 4,5 V) ± 1 % (Stromausgang / current output / sortie courant 4mA ... 20mA)	
Vibrationsfilter vibration filter filtrage des vibrations	Grenzfrequenz typ. 40 Hz (auf Kundenwunsch veränderbar) critical frequency typ. 40 Hz (changeable on customer request) fréquence critique typ. 40 Hz (modifiable sur demande client)	
Signalaktualisierungsrate / signal update rate Vitesse de renouvellement du signal	ca. 100 Hz / appr. 100 Hz / env. 100 Hz	
Start-Up-Time / startup time / vitesse de démarrage	≤ 500 ms	
Gehäusematerial housing material matériau du boîtier	Gehäuseoberteil: PBT GF35, Gehäusedeckel: PC top housing: PBT GF35, housing cover: PC partie sup. du boîtier: PBT GF35, couvercle du boîtier: PC	
Montagebuchse / mounting bush / douille de montage	ø 5,3 mm	
Temperaturbereich / temperature range / plage de température	-40°C...+70°C	
Schutzart / protection class / protection	IP 67 DIN EN 60529	

\* Toleranzangabe bei RT 23°C. Für andere Temperaturen gilt:  $U_{bmin} = T_{amb} * 0,0344 + 9V$ ; tolerance details at room temperature 23°C. applies to other temperatures:  $U_{bmin} = T_{amb} * 0,0344 + 9V$ ;  
 Plage de tension à T 23°C. Pour d'autres températures :  $U_{bmin} = T_{amb} * 0,0344 + 9V$

# Neigungssensor Tilt sensor Capteurs de dévers

360 24.....

Winkelanzeige  
Angle instrument  
Affichage angulaire

U<sub>B</sub>  
24 V

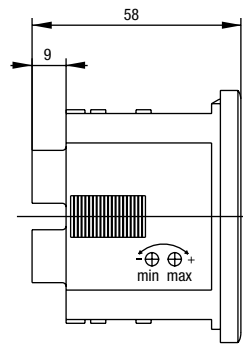
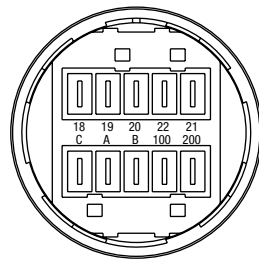
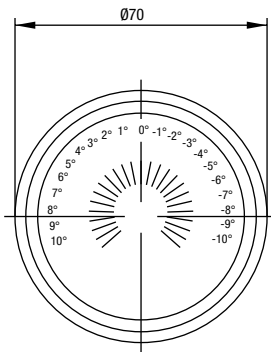

Einbauöffnung: ø 60 mm+0,5mm  
mounting hole: ø 60 mm+0,5mm  
trou pour montage: ø 60 mm+0,5mm

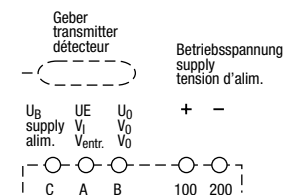

36024 .....

Winkelbereich * angular range plage angulaire	05 = ±5°    10 = ±10°    20 = ±20°    30 = ±30° 06 = ±6°    12 = ±12°    24 = ±24°    36 = ±36°
LED-Farbe (Neutralstellung) colour of LED (neutral position) couleur de la LED ( dévers 0° )	R = rot/red/rouge G = grün/green/verte
LED-Farbe (Winkel) colour of LED (angle) couleurs des LED ( dévers > ou< à 0° )	R = rot/red/rouge G = grün/green/verte
Eingang input entrée	0 = 1 – 5 V 1 = 4 – 20 mA 7 = 0,5 – 4,5 V

\* weitere Winkelbereiche auf Anfrage / further values on request / autres valeurs sur demande

Bestellbeispiel  
Ordering example  
Exemple de commande

360241RG12

Winkelanzeige mit Stromeingang (4–20 mA), mit LED rot für Winkelbereich und LED grün bei 0°, Winkelbereich ±12°  
Angle instrument with current input (4–20 mA), with LED red for angle range and LED green at 0°, angle range ±12°  
Affichage angulaire avec courant d'entrée (4–20 mA), avec affichage rouge pour plage angulaire et affichage vert à 0°, plage angulaire ±12°

Typen Nr. type no. référence	Betriebsspannung operating voltage tension d'alim.	Stromaufnahme current consumption consomm. de courant	Anzeige display affichage	elektronische Verzögerung electronic delay temps de retardement électron.	Temperaturbereich temperature range plage de températ.	Gehäuse housing boîtier	Anschluss connection raccordement
360 24.....	12-24 V DC	< 50 mA	max. 25 LED	ca./approx./env. 0,12 s/LED (25 LED: ca./approx./env. 3 s)	0°C...+50°C	PA	Flachstecker 6 mm 6 mm spade terminals languettes 6 mm





# 8

## Füllstandsmessung Level measurement Mesure de niveau



Tankgeber  
Float switch  
Sonde de niveau à flotteur

111...119



Schüttgutschalter  
Bulk material switch  
DéTECTEURS pour produits en vrac

120...121











Niveauanzeigen  
Level indicators  
Affichages de niveau

122...123





Abgewinkelte Steckervarianten für Tankgeber / angled connector types for float switch / connecteurs couvés pour sonde de niveau			
AMP Superseal 1.5 2-polig / 2-pin / 2 pôles	AMP Superseal 1.5 3-polig / 3-pin / 3 pôles	AMP Seal 16 2-polig / 2-pin / 2 pôles	AMP Seal 16 3-polig / 3-pin / 3 pôles
			
verfügbar / available / disponible	verfügbar / available / disponible	verfügbar / available / disponible	auf Anfrage / on request / sur demande
Metri-Pack 150.2 2-polig / 2-pin / 2 pôles	Metri-Pack 150.2 3-polig / 3-pin / 3 pôles	DT04 2-polig / 2-pin / 2 pôles	DT04 3-polig / 3-pin / 3 pôles
			
auf Anfrage / on request / sur demande	verfügbar / available / disponible	verfügbar / available / disponible	auf Anfrage / on request / sur demande

Gerade Steckervarianten für Tankgeber / straight connectors for float switch / connecteurs droits pour sonde de niveau			
Kabelabgang cable connection départ de cable	Stecker M12 connector M12 connecteur M12	AMP Superseal 2-polig / 2-pin / 2 pôles	AMP Superseal 3-polig / 3-pin / 3 pôles
			
verfügbar / available / disponible	verfügbar / available / disponible	verfügbar / available / disponible	verfügbar / available / disponible
Litzen-/Wellenrohrabgang wire/shaft pipe outlet sortie fils/gaine annelée	DT04 2-polig / 2-pin / 2 pôles	DT04 3-polig / 3-pin / 3 pôles	
			
verfügbar / available / disponible	verfügbar / available / disponible	verfügbar / available / disponible	

elobau Tankgeber / float switch / sonde de niveau: Einsatzmöglichkeiten / applications / domaine d'application		
Diesel	Schmierstoffe / lubricant / lubrifants	Harnstofflösung / urea / urée
Biodiesel	Reinigungsmittel / cleaning agent / produits nettoyeurs	

# Tankgeber

## Float switch for fuel or hydraulic oil

### Sonde de niveau à flotteur



298 ...

Tankgeber  
Float switch for fuel or hydraulic oil  
Sonde de niveau à flotteur

$U_B$   
48 V

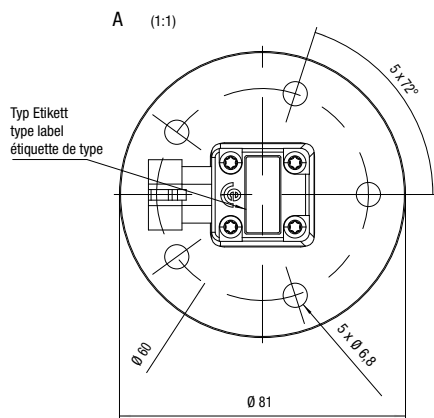
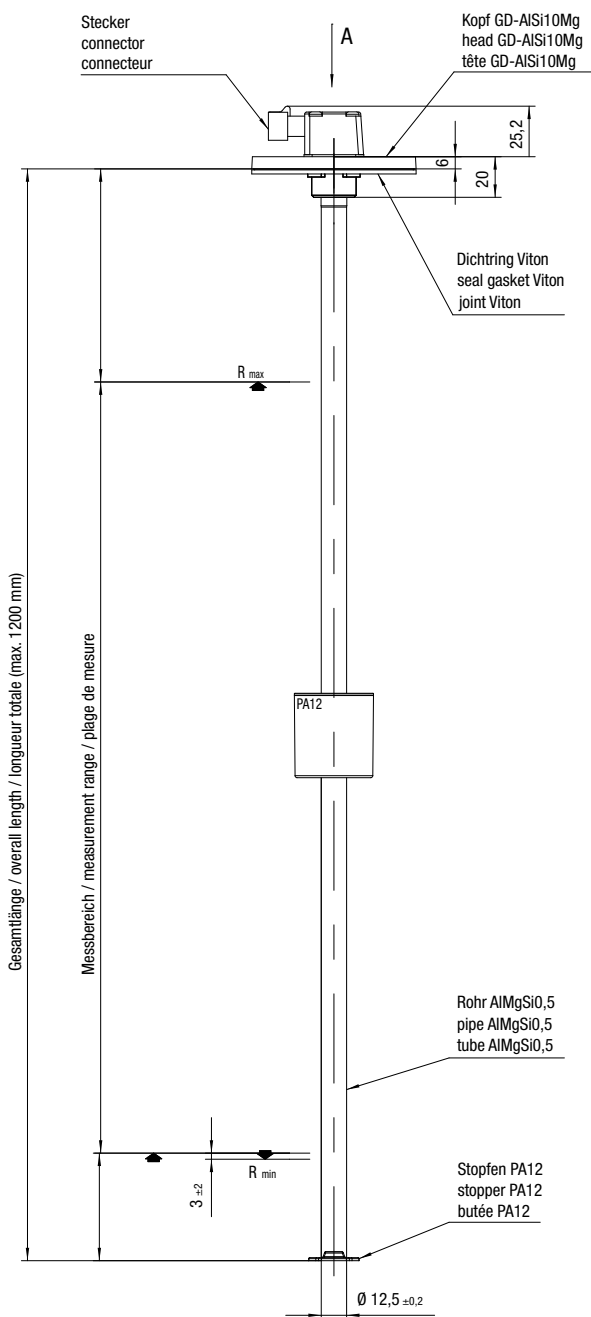

Option / option / option

5-Loch-Flansch  
5-hole flange  
bride à 5 trous

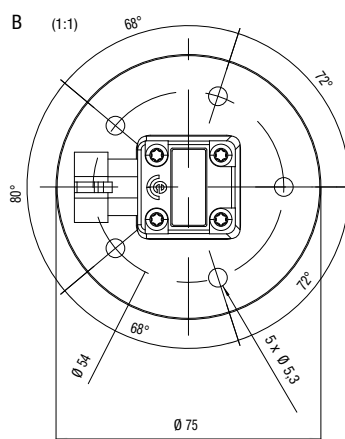

5-Loch-Flansch  
Teilung unterschiedlich  
5-hole flange  
separation differs  
bride à 5 trous  
répartition inégale

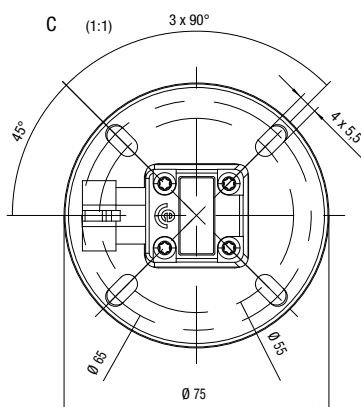

4-Loch-Flansch  
4-hole flange  
bride à 4 trous

Schaltpunkt Definition / definition  
switching point

- ▲ Niveau steigend / rising level
- ▼ Niveau fallend / falling level

Typen Nr. type no. référence	Verlustleistung power loss puissance perdue	Betriebsspannung operating voltage tension d'utilisation	Schaltpunkt switching points points de commutation	Widerstandswerte P70 resistance values P70 valeur de résistance P70
298 ...	PV max. der Widerstände nicht überschreiten do not exceed PV max. of resistances ne pas dépasser le PV max. des résistances	max. 48 V	10er, 20er, 25er, 30er, 35er Raster / grid / espacement	0,6 W ± 1%

# Tankgeber

## Float switch for fuel or hydraulic oil

### Sonde de niveau à flotteur

298 ... Tankgeber  
Float switch for fuel or hydraulic oil  
Sonde de niveau à flotteur

**Gesamtlänge / overall length / longueur totale** (max. 1200 mm)

**Messbereich / measurement range / plage de mesure**

Niveau voll level full niveau plein	Widerstandswert resistor type valeur de résistance
<input type="checkbox"/> R <sub>Max</sub>	
<input type="checkbox"/> R <sub>Min</sub>	

Niveau leer level empty niveau vide	Widerstandswert resistor type valeur de résistance
<input type="checkbox"/> R <sub>Max</sub>	
<input type="checkbox"/> R <sub>Min</sub>	

3±2

Flansch / flange / bride	
<input type="checkbox"/>	5-Loch-Flansch, Teilung 72° / 72° / 72° / 72° / 72° 5-hole flange, separation 72° / 72° / 72° / 72° / 72° Bride à 5 trous, répartition 72° / 72° / 72° / 72° / 72°
<input type="checkbox"/>	5-Loch-Flansch, Teilung 72° / 68° / 80° / 68° / 70° 5-hole flange, separation 72° / 68° / 80° / 68° / 70° Bride à 5 trous, répartition 72° / 68° / 80° / 68° / 70°
<input type="checkbox"/>	4-Loch-Flansch 4-hole flange Bride à 4 trous

Raster / grid / espacement	
<input type="checkbox"/>	10 mm
<input type="checkbox"/>	20 mm
<input type="checkbox"/>	25 mm
<input type="checkbox"/>	30 mm
<input type="checkbox"/>	35 mm

**Steckervarianten / connector types / connecteurs**

Abgewinkelte Stecker Angled connectors Connecteurs coudés	
<input type="checkbox"/>	AMP Superseal, 2-polig / 2-pin / 2 pôles
<input type="checkbox"/>	AMP Superseal, 3-polig / 3-pin / 3 pôles
<input type="checkbox"/>	AMP Seal 16, 2-polig / 2-pin / 2 pôles
<input type="checkbox"/>	DT04, 2-polig / 2-pin / 2 pôles
<input type="checkbox"/>	Metri-Pack 150.2, 3-polig / 3-pin / 3 pôles

Gerade Stecker Straight connectors Connecteurs droits	
<input type="checkbox"/>	Kabelabgang, cable outlet, sortie de câble
<input type="checkbox"/>	Litzen/Wellrohrabgang, wire/shaft pipe outlet, sortie fils/gaine annelée
<input type="checkbox"/>	AMP Superseal, 2-polig / 2-pin / 2 pôles
<input type="checkbox"/>	AMP Superseal, 3-polig / 3-pin / 3 pôles
<input type="checkbox"/>	DT04, 2-polig / 2-pin / 2 pôles
<input type="checkbox"/>	DT04, 3-polig / 3-pin / 3 pôles
<input type="checkbox"/>	Stecker / connector / connecteur M12

Typen Nr. type no. référence	Gesamtwiderstand total resistance résistance totale	Grundwiderstand minimum resistance résistance minimale	Schutzart protection class protection	Material material matériau	Temperaturbereich temperature range plage de température
298 ...	wählbar / selectable / à définir	wählbar / selectable / à définir	IP 67 DIN EN 60529	siehe Zeichnung see technical drawing voir dessin technique	-40° ... +85°C

# Tankgeber mit Entnahme- und Rückführrohr Float switch with fuel feed & return Sonde de niveau avec tube d'aspiration

**351 TEG..0..**

**Tankgeber mit Entnahme- und Rückführrohr  
Float switch with fuel feed & return  
Sonde de niveau avec tube d'aspiration**

$U_B$   
48 V

IP 67



Überwurfmutter Ø 76  
coupling ring Ø 76  
bouchon vissable Ø 76

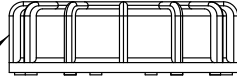

Entlüftung geschlossen/geöffnet  
air vent closed/open  
évent fermé/ouvert

Kopf PA12  
head PA12  
tête PA12

O-Ring Viton  
o-ring Viton  
joint torique  
Viton

VA-Rohr  
VA pipe  
tube inox

Alu-Rohr  
aluminium pipe  
tube en aluminium

Schlauch DIN 73379/A  
hose DIN 73379/A NBR  
tuyau DIN 73379/A NBR

Filterelement VA/POM  
filter element VA/POM  
élément filtrant VA/POM

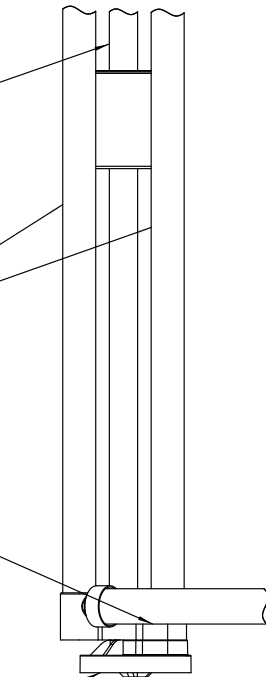
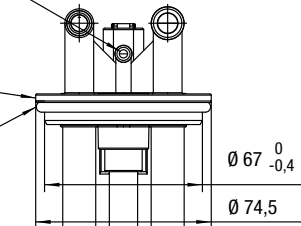

Stecker auf Anfrage  
connector on request  
connecteur sur demande

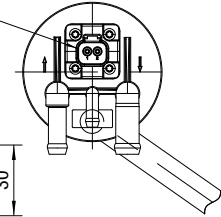

Niveauekopf 825204  
level head 825204  
tête de niveau 825204

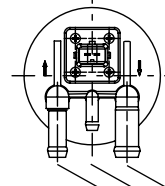

Schlauchanschluss Ø 12,5 mm  
Schlauchanschluss Ø 6,5 mm  
Schlauchanschluss Ø 9,5 mm  
hose connection / raccord  
tuyau

Niveauekopf 825194  
level head 825194  
tête de niveau 825194

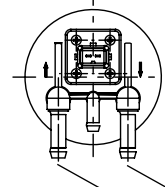

Schlauchanschluss Ø 6,5 mm  
Schlauchanschluss Ø 8 mm  
hose connection / raccord  
tuyau

Niveauekopf 825258  
level head 825258  
tête de niveau 825258

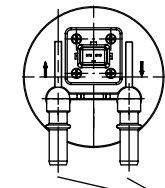

SAE 3/8"  
Anschluss  
connection  
raccord

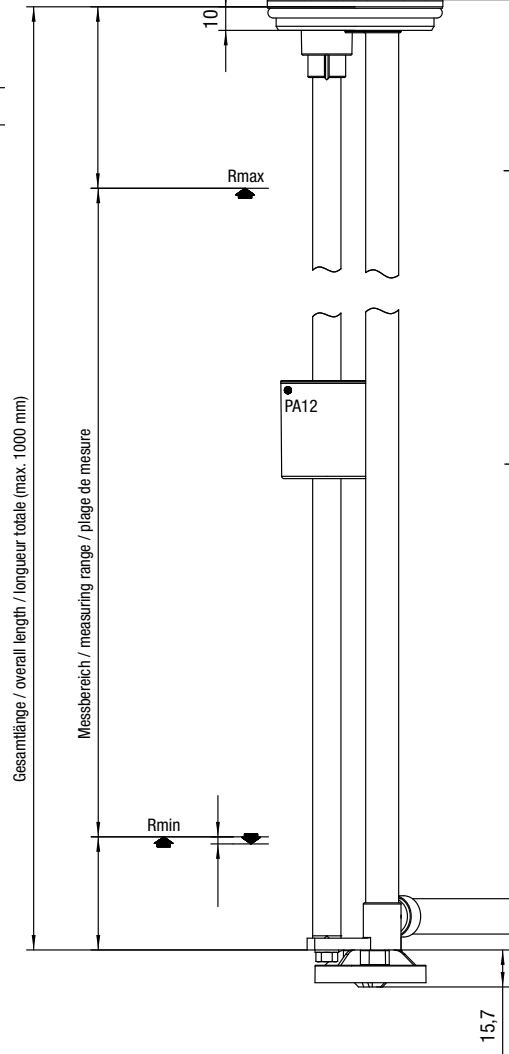

Typen Nr. type no. référence	Verlustleistung power loss puissance perdue	Betriebsspannung operating voltage tension d'utilisation	Schaltpunkt switching points points de commutation	Widerstandswerte P70 resistance values P70 valeur de résistance P70
351 TEG..0..	PV max. der Widerstände nicht überschreiten do not exceed PV max. of resistances ne pas dépasser le PV max. des résistances	max. 48 V	10er, 20er, 25er, 30er, 35er Raster/grid/espacement	0,6 W ± 1%

# Tankgeber mit Entnahme- und Rückführrohr

## Float switch with fuel feed & return

### Sonde de niveau avec tube d'aspiration

#### 351 TEG..0.. Tankgeber mit Entnahme- und Rückführrohr

#### Float switch with fuel feed & return

#### Sonde de niveau avec tube d'aspiration

Kopf / head / tête	
<input type="checkbox"/>	Schlauchanschluss / hose connection / raccord tuyau Ø 12,5 mm / Ø 9,5 mm
<input type="checkbox"/>	Schlauchanschluss / hose connection / raccord tuyau Ø 8 mm
<input type="checkbox"/>	Anschluss / connection / raccord SAE 3/8"

Überwurfmutter coupling ring bouchon vissable	
<input type="checkbox"/>	mit / with / avec
<input type="checkbox"/>	ohne / without / sans

Entlüftung / vent / dégazage	
<input type="checkbox"/>	geöffnet / open / ouvert
<input type="checkbox"/>	geschlossen / close / fermé

Raster / grid / espacement	
<input type="checkbox"/>	10 mm
<input type="checkbox"/>	20 mm
<input type="checkbox"/>	25 mm
<input type="checkbox"/>	30 mm
<input type="checkbox"/>	35 mm

Steckervarianten / connector / connecteur	
Abgewinkelte Stecker Angled connectors Connecteurs coudés	
<input type="checkbox"/>	AMP Superseal, 2-polig / 2-pin / 2 pôles
<input type="checkbox"/>	AMP Superseal, 3-polig / 3-pin / 3 pôles
<input type="checkbox"/>	AMP Seal 16, 2-polig / 2-pin / 2 pôles
<input type="checkbox"/>	DT04, 2-polig / 2-pin / 2 pôles
<input type="checkbox"/>	Metri-Pack 150.2, 3-polig / 3-pin / 3 pôles

Gerade Stecker Straight connectors Connecteurs droits	
<input type="checkbox"/>	Kabelabgang, cable outlet, sortie de câble
<input type="checkbox"/>	Litzen/Wellrohrabgang, wire/shaft pipe outlet, sortie fils/gaine annelée
<input type="checkbox"/>	AMP Superseal, 2-pin / 2-pole / 2 pôles
<input type="checkbox"/>	AMP Superseal, 3-pin / 3-pole / 3 pôles
<input type="checkbox"/>	DT04, 2-polig / 2-pin / 2 pôles
<input type="checkbox"/>	DT04, 3-polig / 3-pin / 3 pôles
<input type="checkbox"/>	Stecker / connector / connecteur M12

Schlauch / hose / tuyau	
<input type="checkbox"/>	mit / with / avec ..... Länge / length / longueur
<input type="checkbox"/>	ohne / without / sans

Filter / filter / filtre	
<input type="checkbox"/>	100 µm
<input type="checkbox"/>	315 µm
<input type="checkbox"/>	ohne / without / sans

Niveau voll level full niveau plein		Widerstandswert resistor type valeur de résistance	
<input type="checkbox"/>	R <sub>Max</sub>		
<input type="checkbox"/>	R <sub>Min</sub>		

Niveau leer level empty niveau vide		Widerstandswert resistor type valeur de résistance	
<input type="checkbox"/>	R <sub>Max</sub>		
<input type="checkbox"/>	R <sub>Min</sub>		

Typen Nr. type no. référence		Gesamtwiderstand total resistance résistance total		Grundwiderstand minimum resistance résistance minimale		Schutzart protection class protection		Material material matériau		Temperaturbereich temperature range plage de température	
351 TEG..0..		wählbar / selectable / à définir		wählbar / selectable / à définir		IP 67 DIN EN 60529		siehe Zeichnung see technical drawing voir dessin technique		-40°...+85°C	

# Tankgeber mit Entnahme- und Rückführrohr

## Float switch with fuel feed & return

### Sonde de niveau avec tube d'aspiration

361 TEA...

Tankgeber mit Entnahme- und Rückführrohr  
Float switch with fuel feed & return  
Sonde de niveau avec tube d'aspiration

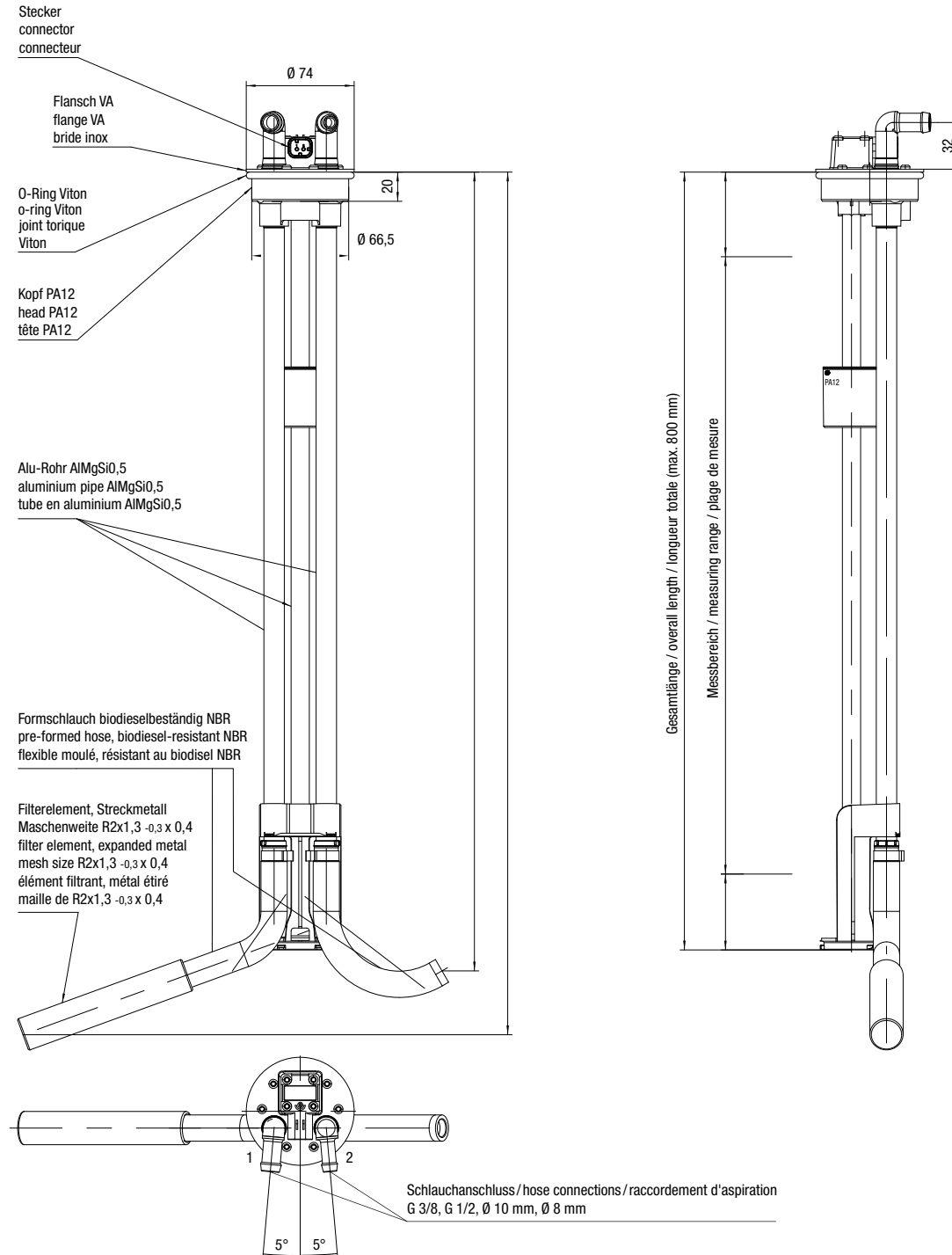
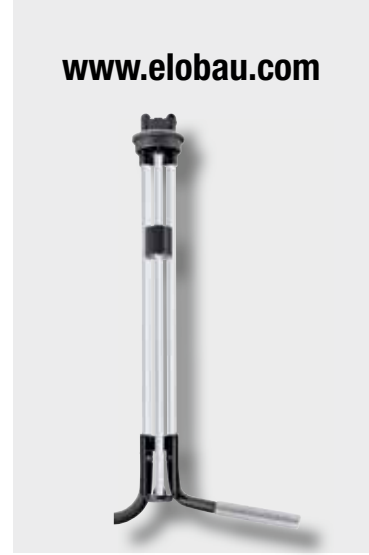
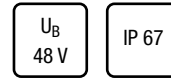

Typen Nr. type no. référence	Verlustleistung power loss puissance perdue	Betriebsspannung operating voltage tension d'utilisation	Schaltpunkt switching points points de commutation	Widerstandswerte P70 resistance values P70 valeur de résistance P70
361 TEA...	PV max. der Widerstände nicht überschreiten do not exceed PV max. of resistances ne pas dépasser le PV max. des résistances	max. 48 V	10er, 20er, 25er, 30er, 35er Raster/grid/espacement	0,6 W ± 1 %



# Tankgeber mit Entnahme- und Rückführrohr

## Float switch with fuel feed & return

### Sonde de niveau avec tube d'aspiration

#### 361 TEA...

Tankgeber mit Entnahme- und Rückführrohr  
Float switch with fuel feed & return  
Sonde de niveau avec tube d'aspiration

Überwurfmutter  
coupling ring  
bouchon vissable

mit / with / avec

ohne / without / sans

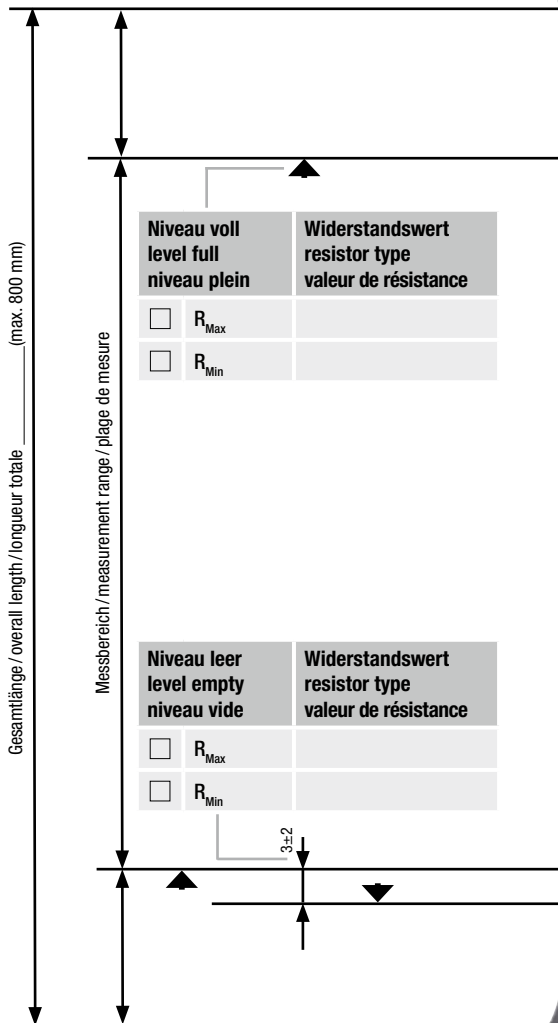

Anschluss / connection / raccordement	
<input type="checkbox"/>	G 3/8 Schlauchanschluss hose connections raccordement d'aspiration
<input type="checkbox"/>	G 1/2
<input type="checkbox"/>	Ø 10 mm 1 = Entnahme / extraction / prélèvement
<input type="checkbox"/>	Ø 8 mm 2 = Rücklauf / return / retour

Entlüftung / air vent / dégazage	
<input type="checkbox"/>	geöffnet / open / ouvert
<input type="checkbox"/>	geschlossen / close / fermé

Raster / grid / espacement			
<input type="checkbox"/>	10 mm	<input type="checkbox"/>	30 mm
<input type="checkbox"/>	20 mm	<input type="checkbox"/>	35 mm
<input type="checkbox"/>	25 mm		

#### Steckervarianten / connector types / connecteurs

Abgewinkelte Stecker Angled connectors Connecteurs coudés	
<input type="checkbox"/>	AMP Superseal, 2-polig / 2-pin / 2 pôles
<input type="checkbox"/>	AMP Superseal, 3-polig / 3-pin / 3 pôles
<input type="checkbox"/>	AMP Seal 16, 2-polig / 2-pin / 2 pôles
<input type="checkbox"/>	DT04, 2-polig / 2-pin / 2 pôles
<input type="checkbox"/>	Metri-Pack 150.2, 3-polig / 3-pin / 3 pôles

Gerade Stecker Straight connectors Connecteurs droits	
<input type="checkbox"/>	Kabelabgang, cable outlet, sortie de câble
<input type="checkbox"/>	Litzen/Wellrohrabgang, wire/shaft pipe outlet, sortie fils/gaine annelée
<input type="checkbox"/>	AMP Superseal, 2-polig / 2-pin / 2 pôles
<input type="checkbox"/>	AMP Superseal, 3-polig / 3-pin / 3 pôles
<input type="checkbox"/>	DT04, 2-polig / 2-pin / 2 pôles
<input type="checkbox"/>	DT04, 3-polig / 3-pin / 3 pôles
<input type="checkbox"/>	Stecker / connector / connecteur M12

Schlauchabgang / hose outlet / sortie tuyau	
<input type="checkbox"/>	mit / with / avec 90° und / and / et 110° (wenn / if / si Filter / filter / filtre)
<input type="checkbox"/>	ohne / without / sans

Filter / filter / filtre	
<input type="checkbox"/>	Maschenweite / mesh size / maille de R2x1,3 <sub>0,3</sub> x4
<input type="checkbox"/>	ohne / without / sans

Typen Nr. type no. référence	Gesamtwiderstand total resistance résistance total	Grundwiderstand minimum resistance résistance minimale	Schutzart protection class protection	Material material matériau	Temperaturbereich temperature range plage de température
361 TEA...	wählbar / selectable / à définir	wählbar / selectable / à définir	IP 67 DIN EN 60529	siehe Zeichnung see technical drawing voir dessin technique	-40°...+85°C

# Tankgeber mit Entnahme- & Rückführrohr und Heizkreislauf

## Float switch with fuel feed & return and heating loop

### Sonde de niveau avec tube d'aspiration et circuits de chauffage



**351 ADBU**

**Tankgeber für SCR-Systeme**  
**Float switch for SCR systems**  
**Sonde de niveau pour système SCR**

U<sub>B</sub>  
48 V

IP 67

Entlüftung verschlossen/geöffnet Ø 4 mm / air vent closed/open Ø 4 mm /  
 dégazage fermé/ouvert Ø 4 mm

Entnahme/extraction/prélèvement  
 SAE 3/8"

Rücklauf/return/retour  
 SAE 3/8"

Heizanschluss Ø 7 mm /  
 heater connection Ø 7 mm /  
 raccordement du chauffage Ø 7 mm  
 und / and / et  
 Buchse / socket / douille  
 Ms63

Kopf/head/tête  
 PA12

Flansch/flange/bride  
 VA 1.4301

O-Ring/o-ring/  
 joint torique  
 NBR

Heizrohr/heating tube/  
 tube chauffant  
 VA 1.4571

Saugrohr/suction tube/  
 tube d'aspiration  
 VA 1.4301

Fußteil  
 base element  
 pied  
 PA12

Filterelement  
 filter element  
 élément filtrant  
 VA 1.4301 / POM

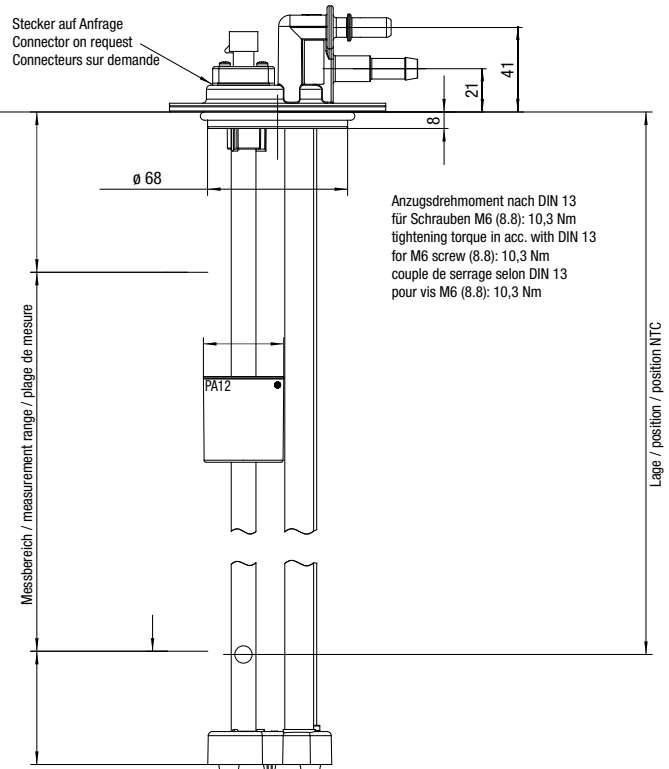
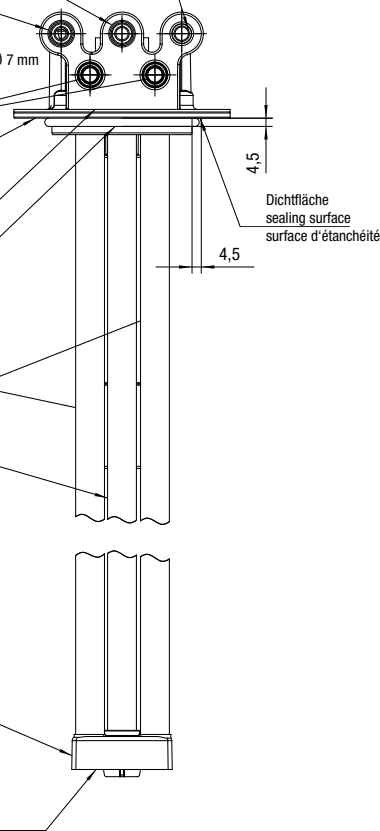

Typen Nr. type no. référence	Verlustleistung power loss puissance perdue	Betriebsspannung operating voltage tension d'utilisation	Schaltpunkt switching points points de commutation	Widerstandswerte P70 resistance values P70 valeur de résistance P70
351 ADBU	PV max. der Widerstände nicht überschreiten do not exceed PV max. of resistances ne pas dépasser le PV max. des résistances	max. 48 V	10er, 20er, 25er, 30er, 35er Raster/grid/espacement	0,6 W ± 1%

# Tankgeber mit Entnahme- & Rückführrohr und Heizkreislauf

## Float switch with fuel feed & return and heating loop

### Sonde de niveau avec tube d'aspiration et circuits de chauffage

#### 351 ADBU

Tankgeber für SCR-Systeme  
 Float switch for SCR systems  
 Sonde de niveau pour système SCR

**Entlüftung / air vent / dégazage**

- geöffnet / open / ouvert
- geschlossen / close / fermé

**Raster / grid / espacement**

- 10 mm
- 20 mm
- 25 mm
- 30 mm
- 35 mm

**Steckervarianten / connector types / connecteurs**

**Abgewinkelte Stecker  
 Angled connectors  
 Connecteurs coudés**

- AMP Superseal, 3-polig / 3-pin / 3 pôles

**Gerade Stecker  
 Straight connectors  
 Connecteurs droits**

- Kabelabgang, cable outlet, sortie de câble
- Litzen/Wellrohrabgang, wire/shaft pipe outlet, sortie fils/gaine annelée
- AMP Superseal, 3-polig / 3-pin / 3 pôles
- DT04, 3-polig / 3-pin / 3 pôles
- Stecker / connector / connecteur M12

**Filter / filter / filtre**

- 100 µm
- 60 µm

**Dimensions and Measurement Range:**

Gesamtlänge / overall length / longueur totale (max. 800 mm)

Messbereich / measurement range / plage de mesure

**Niveau voll / level full / niveau plein**

<input type="checkbox"/> R <sub>Max</sub>	Widerstandswert / resistor type / valeur de résistance
<input type="checkbox"/> R <sub>Min</sub>	

**Niveau leer / level empty / niveau vide**

<input type="checkbox"/> R <sub>Max</sub>	Widerstandswert / resistor type / valeur de résistance
<input type="checkbox"/> R <sub>Min</sub>	

3±2

Typen Nr. type no. référence	Gesamtwiderstand total resistance résistance total	Grundwiderstand minimum resistance résistance minimale	Schutzart protection class protection	Material	Temperaturbereich temperature range plage de température
351 ADBU	wählbar / selectable / à définir	wählbar / selectable / à définir	IP 67 DIN EN 60529	siehe Zeichnung see technical drawing voir dessin technique	-40°...+85°C

# Schüttgutschalter Bulk material switch DéTECTEURS pour produits en vrac



## 119 ... DA

mit Kabelausgang, geeignet für Medien welche sich keilförmig anhäufen, z.B. Getreide  
with cable output, suitable for products which pile up in a conical shape avec sôrtie cable, convient aux matières qui s'entassent en prenant une forme conique, comme les céréales

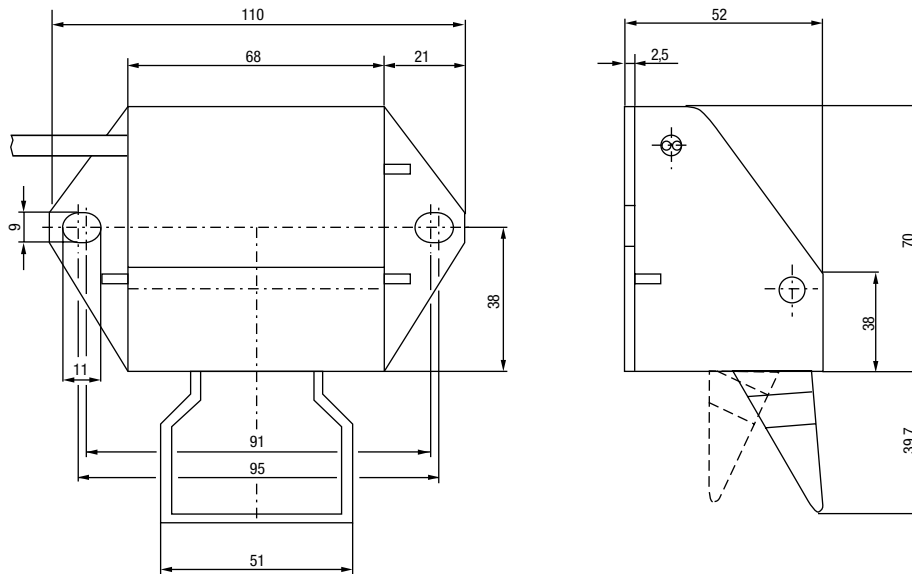

### Schaltbild Circuit diagram Schéma du circuit

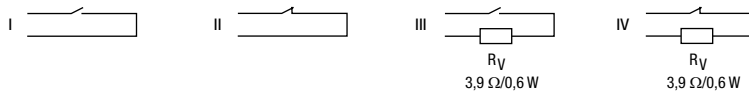

Typen Nr. type no. référence	Schaltspannung switching voltage tension de commutation	Schaltstrom switching current courant de commutation	Schaltleistung switching power pouvoir de coupure	Vorwiderstand series resistor résistance en série	Kabel cable câbles
119 000 DA	max. 48 V	max. 0,5 A	max. 10/10 W/VA	nein/no/non	PVC, 1 m ± 30 mm, 0,25 mm <sup>2</sup>
119 010 DA		max. 0,5 A		nein/no/non	
119 100 DA		max. 0,3 A*		ja/yes/oui	
119 110 DA		max. 0,3 A*		ja/yes/oui	

Typen Nr. type no. référence	Kontaktart contact form type de contact	Material material matériau	Temperaturbereich (PP) temperature range (PP) plage de température (PP)	Schaltbild circuit diagram schéma du circuit
119 000 DA	Schließer / N.O. / NO	PA	-25...+75°C	I
119 010 DA	Öffner / N.C. / NF			II
119 100 DA	Schließer / N.O. / NO			III
119 110 DA	Öffner / N.C. / NF			IV

\* kurzzeitig 0,5 A  
short-time 0,5 A  
de peu de durée 0,5 A

# Schüttgutschalter Bulk material switch DéTECTEURS pour produits en vrac

48 V

www.elobau.com

**119 ... DB** mit Steckerausgang  
with plug output  
avec sortie connecteur

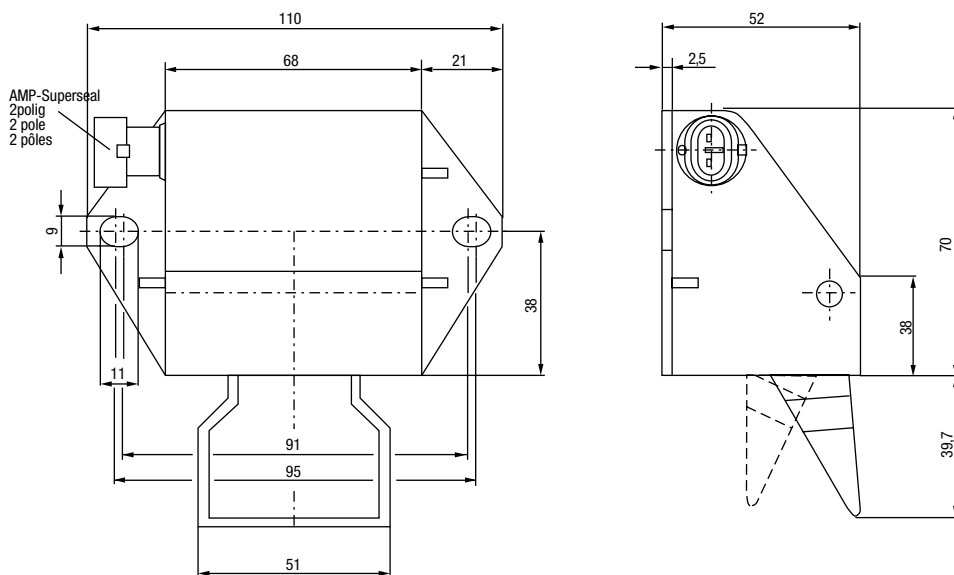

Kabelsatz LOBC00.B01 siehe S. 127.  
Cable set LOBC00.B01 see p. 127.  
Câble associé LOBC00.B01 voir p. 127.

## Schaltbild Circuit diagram Schéma du circuit

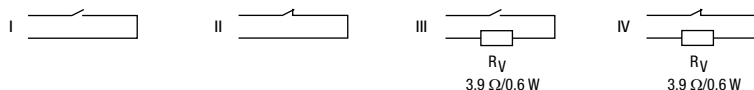

Typen Nr. type no. référence	Schaltspannung switching voltage tension de commutation	Schaltstrom switching current courant de commutation	Schaltleistung switching power pouvoir de coupure	Vorwiderstand series resistor résistance en série
119 000 DB	max. 48 V	max. 0,5 A	max. 10/10 W/VA	nein/no/non
119 010 DB		max. 0,5 A		nein/no/non
119 100 DB		max. 0,3 A*		ja/yes/oui
119 110 DB		max. 0,3 A*		ja/yes/oui

Typen Nr. type no. référence	Kontaktart contact form type de contact	Material material matériau	Temperaturbereich (PP) temperature range (PP) plage de température (PP)	Schaltbild circuit diagram schéma du circuit
119 000 DB	Schließer / N.O. / NO	PA	-25...+75°C	I
119 010 DB	Öffner / N.C. / NF			II
119 100 DB	Schließer / N.O. / NO			III
119 110 DB	Öffner / N.C. / NF			IV

\* kurzzeitig 0,5 A  
short-time 0,5 A  
de peu de durée 0,5 A

Änderungen und Irrtümer bleiben vorbehalten. Abbildungen ähnlich. Maßgeblich sind die dem ausgelieferten Produkt beigelegten technischen Dokumentationen.  
The relevant corresponding technical documents will be supplied with the product. Certain product descriptions can be similar therefore please ensure that you have the latest version of documentation for your specific product prior to any use. elobau reserves the right to change technical data and documentation without notice.  
Sous réserve de modifications et d'erreurs. Images similaires. Les documentations techniques accompagnant les produits sont d'application.

made  
in  
Germany

no CO<sub>2</sub>

Wir produzieren klimaneutral.  
We produce in a carbon-neutral manner.  
Nous produisons avec un bilan carbone neutre.

121

# Niveauanzeigen für analoge Eingangssignale

## Level indicators for analogue input signals

### Affichages de niveau pour des signaux d'entrée analogiques

360 28. .K

Rundinstrument  
Circular instrument  
Affichage circulaire

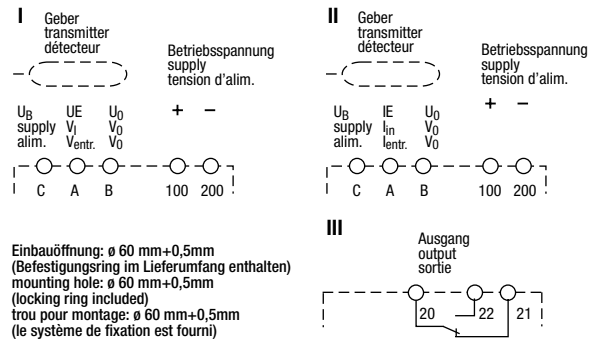
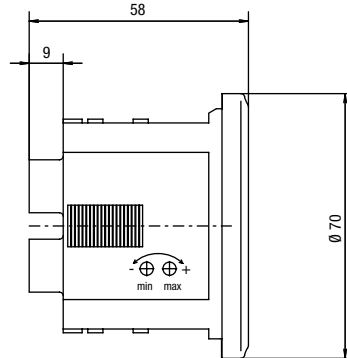
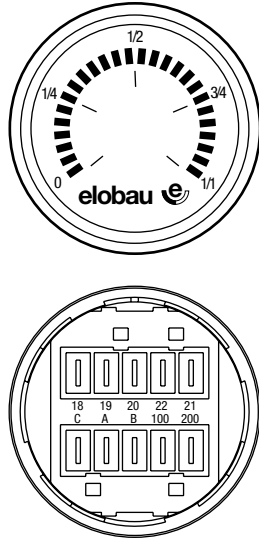
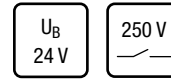

Typen Nr. type no. référence	Betriebsspannung operating voltage tension d'alim.	Stromaufnahme current consumption consommation	Eingang input entrée	Bemerkung remark remarques	Schaltbild circuit diagram schéma de raccordement	
360 280 ..	12-24 V DC	100 mA	0-5 V	ohne Auswertung without relay outputs sans contrôle	I	
360 28J ..	12-24 V DC		0,5-4,5 V		I	
360 28L ..	12-24 V DC		1-5 V		I	
360 281 ..	12-24 V DC		0-20 mA		II	
360 28K ..	12-24 V DC		4-20 mA		II	
360 282 ..	24 V DC		0-5 V		2-Punkt*/autofill*/2 points*	I + III
360 28A ..	24 V DC		0,5-4,5 V		2-Punkt*/autofill*/2 points*	I + III
360 28C ..	24 V DC		1-5 V		2-Punkt*/autofill*/2 points*	I + III
360 283 ..	24 V DC		0-20 mA		2-Punkt*/autofill*/2 points*	II + III
360 28B ..	24 V DC		4-20 mA		2-Punkt*/autofill*/2 points*	II + III
360 286 ..	12 V DC		0-5 V		2-Punkt*/autofill*/2 points*	I + III
360 28E ..	12 V DC		0,5-4,5 V		2-Punkt*/autofill*/2 points*	I + III
360 28G ..	12 V DC		1-5 V		2-Punkt*/autofill*/2 points*	I + III
360 287 ..	12 V DC		0-20 mA		2-Punkt*/autofill*/2 points*	II + III
360 28F ..	12 V DC		4-20 mA		2-Punkt*/autofill*/2 points*	II + III

\*Schaltpunkte können nur vom Hersteller eingestellt werden.  
\*Switching points must be specified when ordering.  
\*Les points de commutation ne peuvent être réglés que par le fabriquant.

Typen Nr. type no. référence	Nullpunkt zero point point zéro	max. Punkt max. point point maxi	Auflösung resolution sensibilité	Anzeige LED display LED affichage LED	Temperaturbereich temperature range plage de température	Anschluss connection raccordement
360 28. ...	einstellbar adjustable réglable	einstellbar adjustable réglable	4 %	Kette bargraph bargraph	0...+50°C	Flachstecker 6,3 mm 6,3 mm spade terminal languettes 6,3 mm

7. und 8. Stelle / 7th and 8th digit / 7<sup>ème</sup> et 8<sup>ème</sup> position

GK = 24-LED-Kette grün / green 24-LED bargraph / chaîne de 24 LED vertes

RK = 24-LED-Kette rot / red 24-LED bargraph / chaîne de LED rouges

# Niveauanzeigen für digitale Eingangssignale

## Level indicators for digital input signals

### Affichages de niveau pour des signaux d'entrée digitaux

360 282 ../283 ../286 ../287..

Niveauanzeigen  
Level indicators  
Affichages de niveau

Anzeigen mit Auswertung  
Displays with relay outputs  
Affichages avec contrôle

Type Nr. type no. référence	Schaltspannung switching voltage tension de commutation	Schaltstrom switching current courant de commutation	Schaltleistung switching power pouvoir de coupure	Schutzart protection class protection
360 282 .. 360 28A .. 360 28C .. 360 283 .. 360 28B .. 360 286 .. 360 28E .. 360 28G 360 287 .. 360 28F ..	250 V AC/30 V DC	3 A	750 VA/90 W	IP 64 (Frontseite/face/face) IP 00 (Rückseite/body/boitier)

Schlüssel zur Kennzeichnung der Schaltpunkte  
Specification of switching points  
Spécification de points de commutation

1. Stelle/1st letter/1ère lettre											2. Stelle/2nd letter/1ème lettre																									
EIN OPERATE MARCHE											Wechsler-Relais C.O. relay inverseur																									
AUS RELEASE ARRÊT																																				
Schaltpunkt EIN: B bis X lower switching point: B to X point de commutation inférieur: B à X											Schaltpunkt AUS: B bis X upper switching point: B to X point de commutation supérieur: B à X																									
B	C	D	E	F	G	H	I	J	K	L	M	N	O	P	Q	R	S	T	U	V	W	X														
2	3	4	5	6	7	8	9	10	11	12	13	14	15	16	17	18	19	20	21	22	23	24														

#### Funktion des Wechsler-Relais

Der erste Schaltpunkt legt das Anziehen des Relais fest, der zweite Schaltpunkt das Abfallen. Der jeweilige Schaltvorgang findet beim Erreichen des höheren Schaltpunktes bzw. beim Unterschreiten des niedrigeren Schaltpunktes statt.

#### Relay function

Relay shown without power applied. Therefore, with power applied, and level below the upper switching point, the relay is operated. Once the level exceeds the upper switching point the relay releases, and will only operate again once the level falls below the lower switching point.

#### Fonctionnement de la sortie relais inverseur

Les contacts des relais sont représentés en l'absence d'alimentation. Lorsque l'unité est mise sous tension et affiche un niveau minimum, le relais est alimenté et les contacts basculent. Lorsque le niveau atteint le point de commutation supérieure, le relais est désactivé et les contacts reviennent à leurs position de repos. Lorsque le niveau retombe en dessous du point de commutation inférieur, le relais est de nouveau alimenté et les contacts basculent.

Bestellbeispiel  
Example  
Exemple

360 286 RK J T

Relais	EIN = 10. LED	AUS = 20. LED
Relay	OPERATE = LED 10	RELEASE = LED 20
Relais	MARCHE = LED 10	ARRÊT = LED 20





# 9

## Kabelsätze Cable sets Câbles



Kabelsätze  
Cable sets  
Câbles

127...131





**LO.C00.B 01**      **Superseal**  
**Superseal**  
**Superseal**

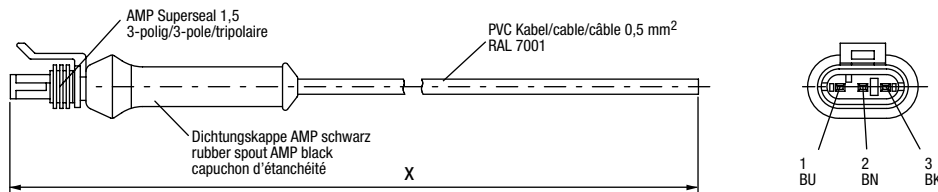

**LO.C00.B 01**

<b>Kabellänge x</b>	<b>cabl length x</b>	<b>longueur de câble x</b>
1 = 1 m ± 30 mm	1 = 1 m ± 30 mm	1 = 1 m ± 30 mm
3 = 3 m ± 40 mm	3 = 3 m ± 40 mm	3 = 3 m ± 40 mm
5 = 5 m ± 60 mm	5 = 5 m ± 60 mm	5 = 5 m ± 60 mm
0 = 10 m ± 80 mm	0 = 10 m ± 80 mm	0 = 10 m ± 80 mm
<b>Anschlusspol</b>	<b>connection poles</b>	<b>pôle de raccordement</b>
B = zweipolig	B = 2-pole	B = bipolaire
C = dreipolig	C = 3-pole	C = tripolaire

**LOFD.0.B**      **Micro Quadlock 6-polig**  
**Micro Quadlock 6-pole**  
**Micro Quadlock 6 pôles**

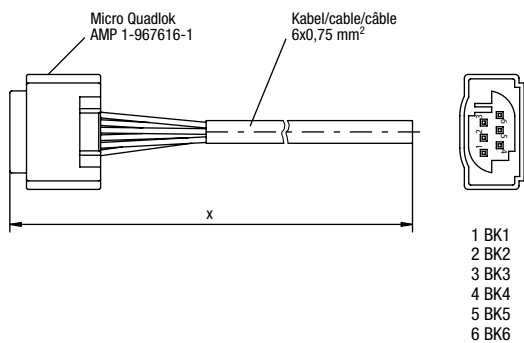

**LOFD.0.B**

<b>Kabellänge x / cabl length x / longueur de câble x</b>
0 = 10 m ± 80 mm
1 = 1 m ± 30 mm
2 = 2 m ± 40 mm
3 = 3 m ± 40 mm
4 = 4 m ± 60 mm
5 = 5 m ± 60 mm
6 = 6 m ± 60 mm
7 = 7 m ± 60 mm
8 = 8 m ± 60 mm
9 = 9 m ± 60 mm
<b>Kabelmaterial/cable material/matériau de câble</b>
0 = PVC grau/grey/gris
1 = PUR schwarz/black/noir

**L1FD.0.B**      **Deutsch Stecker DT 6-polig**  
**Deutsch connector DT 6-pole**  
**Connecteur Deutsch DT 6 pôles**

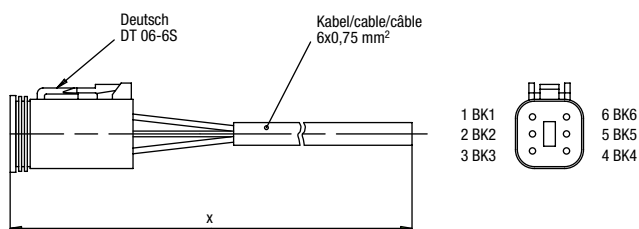

**L1FD.0.B**

**Kabellänge x / cable length x / longueur de câble x**

- 0 = 10 m ± 80 mm
- 1 = 1 m ± 30 mm
- 2 = 2 m ± 40 mm
- 3 = 3 m ± 40 mm
- 4 = 4 m ± 60 mm
- 5 = 5 m ± 60 mm
- 6 = 6 m ± 60 mm
- 7 = 7 m ± 60 mm
- 8 = 8 m ± 60 mm
- 9 = 9 m ± 60 mm

**Kabelmaterial / cable material / matériau de câble**

- 0 = PVC grau/grey/gris
- 1 = PUR schwarz/black/noir

**LOZD.0.B**      **Micro Quadlock AMP**  
**Micro Quadlock AMP**  
**Micro Quadlock AMP**

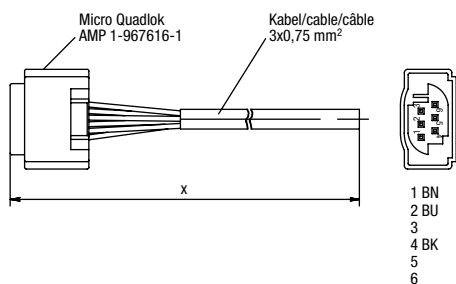

**LOZD.0.B**

**Kabellänge x / cable length x / longueur de câble x**

- 0 = 10 m ± 80 mm
- 1 = 1 m ± 30 mm
- 2 = 2 m ± 40 mm
- 3 = 3 m ± 40 mm
- 4 = 4 m ± 60 mm
- 5 = 5 m ± 60 mm
- 6 = 6 m ± 60 mm
- 7 = 7 m ± 60 mm
- 8 = 8 m ± 60 mm
- 9 = 9 m ± 60 mm

**Kabelmaterial / cable material / matériau de câble**

- 0 = PVC grau/grey/gris
- 1 = PUR schwarz/black/noir

**L1ZD.0.B**      **Deutsch Stecker DT 06-6S 3-polig**  
**Deutsch connector DT 06-6S 3-pole**  
**Connecteur Deutsch DT 06-6S 3 pôles**

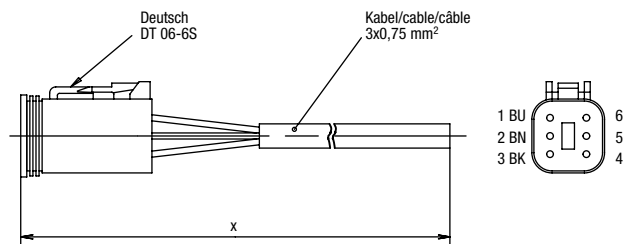

**L1ZD.0.B**

**Kabellänge x / cable length x / longueur de câble x**

- 0 = 10 m ± 80 mm
- 1 = 1 m ± 30 mm
- 2 = 2 m ± 40 mm
- 3 = 3 m ± 40 mm
- 4 = 4 m ± 60 mm
- 5 = 5 m ± 60 mm
- 6 = 6 m ± 60 mm
- 7 = 7 m ± 60 mm
- 8 = 8 m ± 60 mm
- 9 = 9 m ± 60 mm

**Kabelmaterial / cable material / matériau de câble**

- 0 = PVC grau/grey/gris
- 1 = PUR schwarz/black/noir



**L1HC00.B**      **Deutsch Stecker DT 8-polig**  
**Deutsch connector DT 8-pole**  
**Connecteur Deutsch DT 8 pôles**

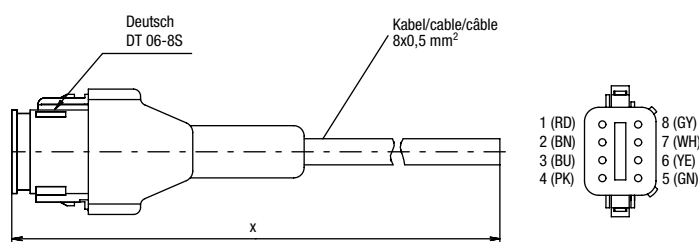

**L1HC00.B**

**Kabellänge x / cable length x / longueur de câble x**

- 0 = 10 m ± 80 mm
- 1 = 1 m ± 30 mm
- 2 = 2 m ± 40 mm
- 3 = 3 m ± 40 mm
- 4 = 4 m ± 60 mm
- 5 = 5 m ± 60 mm
- 6 = 6 m ± 60 mm
- 7 = 7 m ± 60 mm
- 8 = 8 m ± 60 mm
- 9 = 9 m ± 60 mm

Dieser Kabelsatz ist für alle Varianten der Neigungssensoren N3 und N4 ausgelegt. Das Kabel ist bei -40°C flexibel verlegbar.  
This cable kit is suitable for all variants of the tilt sensors N3 and N4. The cable can be laid flexibly at -40°C.  
Ce jeu de câbles est prévu pour toutes les versions de détecteurs d'inclinaison N3 et N4. Le câble est posé de manière flexible à -40°C.



**Kabelsätze**  
**Cable sets**  
**Câbles**

**L1HC00.B4**      **Deutsch Stecker DT 4-polig**  
**Deutsch connector DT 4-pole**  
**Connecteur Deutsch DT 4 pôles**

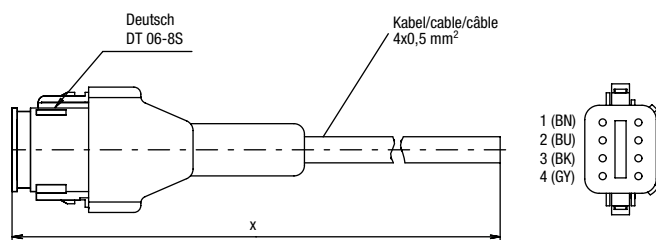

**L1HC00.B4**

**Kabellänge x / cable length x / longueur de câble x**

- 0 = 10 m ± 80 mm
- 1 = 1 m ± 30 mm
- 2 = 2 m ± 40 mm
- 3 = 3 m ± 40 mm
- 4 = 4 m ± 60 mm
- 5 = 5 m ± 60 mm
- 6 = 6 m ± 60 mm
- 7 = 7 m ± 60 mm
- 8 = 8 m ± 60 mm
- 9 = 9 m ± 60 mm

**Artikelverwendung / item usage / utilisation de l'article:**

NxAAxxxxx  
NxBAxxxxx

**L1HC00.B4A**      **Deutsch Stecker DT 4-polig**  
**Deutsch connector DT 4-pole**  
**Connecteur Deutsch DT 4 pôles**

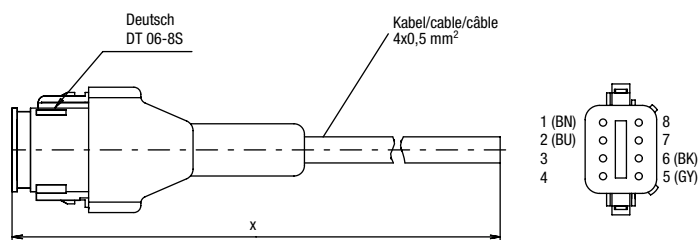

**L1HC00.B4A**

**Kabellänge x / cable length x / longueur de câble x**

- 0 = 10 m ± 80 mm
- 1 = 1 m ± 30 mm
- 2 = 2 m ± 40 mm
- 3 = 3 m ± 40 mm
- 4 = 4 m ± 60 mm
- 5 = 5 m ± 60 mm
- 6 = 6 m ± 60 mm
- 7 = 7 m ± 60 mm
- 8 = 8 m ± 60 mm
- 9 = 9 m ± 60 mm

**Artikelverwendung / item usage / utilisation de l'article:**

NxBxxGxxxxxxx  
NxBxxExxxxxxx  
NxBxxCxxxxxxx  
NxBxxAxxxxxxx

NxAxxGxxxxxxx  
NxAxxExxxxxxx  
NxAxxCxxxxxxx  
NxAxxAxxxxxxx

**L2.D00.A**      **Molex**  
**Molex**  
**Molex**

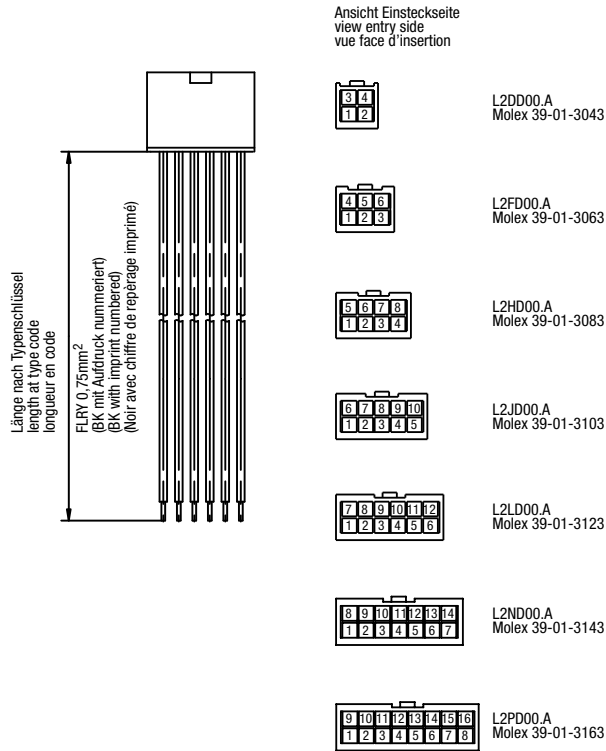

**L2.D00.A**

	<b>Länge (m)</b>	<b>length (m)</b>	<b>longueur (m)</b>
	1 = 1 m ± 30 mm	1 = 1 m ± 30 mm	1 = 1 m ± 30 mm
	2 = 2 m ± 40 mm	2 = 2 m ± 40 mm	2 = 2 m ± 40 mm
	...	...	...
	<b>Anschlusspole</b>	<b>connection poles</b>	<b>pôles de raccordement</b>
	D = 4-polig	D = 4-pole	D = 4 broches
	F = 6-polig	F = 6-pole	F = 6 broches
	H = 8-polig	H = 8-pole	H = 8 broches
	J = 10-polig	J = 10-pole	J = 10 broches
	L = 12-polig	L = 12-pole	L = 12 broches
	N = 14-polig	N = 14-pole	N = 14 broches
	P = 16-polig	P = 16-pole	P = 16 broches

Typen Type Références	Kapitel Chapter Chapitre	Seite Page Page
119...DA	8	120
119...DB	8	121
144 002 04	5	79
144 015 0201	5	79
14401602	5	80
14452105	5	81
14481001	5	81
144810V02	5	81
145...A.	4	59–61
145 DW4.A..	4	73
145 MD4.A..	4	72
145 MA.....	4	70–71
145 MT...	4	62–64
145 MR.....	4	65–66
145 MG.....	4	65–66
145 NTG.....	4	67–69
145 PTO 10 .00	4	74
151 DT 01	3	52
151 PTO...	4	75
151 U...A	2	18
151 U...B	2	19
151 LSS...	2	21
151SL.....	2	20
175 D...	3	53–55
298...	8	112–113
341 G.../ 342 G...	3	47–48
351 ADBU	8	118–119
351CM...	3	43
351 CM 006C00	3	44
351 G....	3	45–46
351H008	2	22
351 TEG..0..	8	114–115
351 RHS.....	2	17
360 24.....	7	107
360 28..K	8	122
360 28.	8	123

Typen Type Références	Kapitel Chapter Chapitre	Seite Page Page
361 G.../ 362 G....	3	49–51
361 TEA...	8	116–117
424 A.. A....	6	85–87
424 C.360	6	93–94
424 D.....	6	91–92
424 R. ...	6	88–90
424 Z....	6	95
N3	7	99–102
N4	7	103–106
J1	3	25–27
J2	3	28–30
J3	3	31–33
J4	3	38–42
J5	3	39–42
J6	3	34–37
L0.C00.B 01	9	127
L0FD.0.B	9	127
L0ZD.0.B	9	128
L1FD.0.B	9	128
L1HC00.B	9	129
L1HC00.B4	9	130
L1HC00.B4A	9	130
L1ZD.0.B	9	129
L2.D00.A	9	131









# Vertretungen international International Agencies Agences Internationales



**Australia**  
AMBIT Instruments Pty. Ltd  
42 Titan Drive  
Carrum Downs  
AUS - Victoria, 3201  
Tel. +61 (0) 3 97 76 88 88  
Fax +61 (0) 3 97 76 86 56  
E-Mail [contact@ambitinst.com.au](mailto:contact@ambitinst.com.au)  
[www.ambitinst.com.au](http://www.ambitinst.com.au)



**Austria**  
elobau Austria GmbH  
Edt 12  
A - 5325 Plainfeld / Salzburg  
Tel. +43 (0) 6229 298 73  
Fax +43 (0) 6229 298 74  
E-Mail [info@elobau.at](mailto:info@elobau.at)  
[www.elobau.at](http://www.elobau.at)



**Benelux**  
elobau Benelux B.V.  
Solingenstraat 37  
NL - 7421 ZP Deventer  
Tel. +31 (0)570-833103  
Fax +31 (0)570-833104  
E-Mail [benelux@elobau.com](mailto:benelux@elobau.com)  
[www.elobau.nl](http://www.elobau.nl)



**Canada**  
X Tronics Inc.  
3-400 Creditstone Rd.  
Concord, ON L4K 3Z3  
Tel. 905 - 660 - 05 55  
Fax 905 - 660 - 05 59  
Toll Free within Canada: 1 - 866 - 413 - 2971  
E-Mail [claudex@xtronics.ca](mailto:claudex@xtronics.ca)  
[www.xtronics.ca](http://www.xtronics.ca)



**China**  
Junhe Automation (Shanghai) Co.,Ltd  
RM.18 No.199 jingbian Road Bright Venice  
Shanghai  
Tel. +86 (0) 21 - 61 85 15 32  
Fax +86 (0) 21 - 61 49 77 31  
E-Mail [jhaautomation168@126.com](mailto:jhaautomation168@126.com)  
[www.shjunhe168.com](http://www.shjunhe168.com)



**Croatia**  
Bibus Zagreb d.o.o.  
Anina 91  
HR - 10000 Zagreb  
Tel. +385 (0) 13 81 80 04  
Fax +385 (0) 13 81 80 05  
E-Mail [bibus@bibus.hr](mailto:bibus@bibus.hr)  
[www.bibus.hr](http://www.bibus.hr)



**Czech Republic**  
Bibus s.r.o.  
Videnská 125  
CZ - 63927 BRNO  
Tel. +420 (0) 5 47 12 53 00  
Fax +420 (0) 5 47 12 53 10  
E-Mail [bibus@bibus.cz](mailto:bibus@bibus.cz)  
[www.bibus.cz](http://www.bibus.cz)



**Denmark**  
Bennike & Wander A/S  
Handvaerkerbyen 57  
DK - 2670 Greve  
Tel. +45 (0) 43 90 80 00  
Fax +45 (0) 43 69 00 90  
E-Mail [bewael@bewael.dk](mailto:bewael@bewael.dk)  
[www.bennike-wander.dk](http://www.bennike-wander.dk)



**Finland**  
Promaatio Oy  
Kellonsoittajantie 2  
FIN - 02770 ESPOO  
Tel. +358 10 292 22 00  
Fax +358 9 855 43 30  
E-Mail [info@promaatio.fi](mailto:info@promaatio.fi)  
[www.promaatio.fi](http://www.promaatio.fi)



**France**  
elobau France S.a.r.l.  
109, Rue du 1<sup>er</sup> Mars 1943  
F - 69100 Villeurbanne  
Tel. +33 (0) 4 37 91 31 31  
Fax +33 (0) 4 37 91 31 30  
E-Mail [contact@elobau-france.fr](mailto:contact@elobau-france.fr)  
[www.elobau-france.fr](http://www.elobau-france.fr)



**Great Britain**  
elobau UK Limited  
3000 Aviator Way  
Manchester  
GB - M225TG  
Tel. +44 (0) 161 26 61 18 0  
Fax +44 (0) 161 26 61 00 1  
E-Mail [uk-sales@elobau.com](mailto:uk-sales@elobau.com)  
[www.elobau.com](http://www.elobau.com)



**Hungary**  
Bibus Kft  
Újhegyi út 2  
HU - 1103 Budapest  
Tel. +36 (0) 12 65 27 33  
Fax +36 (0) 12 64 89 00  
E-Mail [info@bibus.hu](mailto:info@bibus.hu)  
[www.bibus.hu](http://www.bibus.hu)



**Israel**  
S.Kahane & Sons Ltd.  
Haomanut 9 str., South industrial zone  
42160 Netanya  
Tel. 9 72 - 98 63 30 00  
Fax 9 72 - 98 85 12 50  
E-Mail [omer@kahane.co.il](mailto:omer@kahane.co.il)  
[www.shlomokahane.co.il](http://www.shlomokahane.co.il)



**Italy**  
Tritecnica SPA  
Viale Lazio, 26  
I - 20135 Milano  
Tel. +39 (0) 2 54 19 41  
Fax +39 (0) 2 55 01 04 74  
E-Mail [info@tritecnica.it](mailto:info@tritecnica.it)  
[www.tritecnica.it](http://www.tritecnica.it)



**Japan**  
elobau Japan K.K.  
Level 8, Nittochi Nishi-Shinjuku Building  
6-10-1 Nishi-Shinjuku  
Shinjuku-ku  
J - 160-0023 Tokyo  
Tel. +81 (0) 3 5325 3302  
Fax +81 (0) 3 5325 3232  
E-Mail [t.nagahashi@elobau.co.jp](mailto:t.nagahashi@elobau.co.jp)  
[www.elobau.co.jp](http://www.elobau.co.jp)



**Korea**  
Mirae E & I Co.  
#401, IT Mirae Tower 60-21  
Gasam-Dong, Geumcheon-Gu  
153-760 Seoul (Süd Korea)  
Tel. +82-2-2027-5858  
Fax +82-2-2027-5855  
[www.fa119.com](http://www.fa119.com)



**Poland**  
Bibus Menos sp. zo.o.  
ul. Spadochroniarzy 18  
PL - 80-298 Gdansk  
Tel. +48 (0) 58 660 95 70  
Fax +48 (0) 58 661 71 32  
E-Mail [info@bibusmenos.pl](mailto:info@bibusmenos.pl)  
[www.bibusmenos.pl](http://www.bibusmenos.pl)



**Portugal**  
Bibus Portugal  
Rua 5 de Outubro, 5026  
P-4465-079 S. M. Infesta  
Tel. +35 (1) 22 9 06 50 50  
Fax +35 (1) 22 9 06 50 53



**Russia**  
Bibus o.o.o.  
Izmailovskiy pr.2 lit. A  
RUS - 190005 Saint-Petersburg  
Tel. +7 (0) 812 251-0  
Fax +7 (0) 812 251 62 71  
E-Mail [info@bibus.ru](mailto:info@bibus.ru)  
[www.bibus.ru](http://www.bibus.ru)



**Singapore**  
Precision Technologies Pte Ltd.  
211 Henderson Road #13-02  
Henderson Industrial Park  
159552 Singapore  
Tel. +65 (0)6273 4573  
E-mail [precision@pretech.com.sg](mailto:precision@pretech.com.sg)



**Slovakia**  
Bibus SK s.r.o.  
Trnavska 31  
SK - 94901 Nitra  
Tel. +421 (0) 3 77 41 25 25  
Fax +421 (0) 3 76 51 67 01  
E-Mail [sale@bibus.sk](mailto:sale@bibus.sk)  
[www.bibus.sk](http://www.bibus.sk)



**Slovenia**  
Inotech d.o.o.  
K Železnici 7  
SL - 2345 Bistrica ob Dravi  
Tel. +386 (0) 2 665 11 31  
Fax +386 (0) 2 665 20 81  
E-Mail [info@inotech.si](mailto:info@inotech.si)  
[www.inotech.si](http://www.inotech.si)



**Spain**  
CONTAVAL,S.L.  
C/Benjamin Franklin, No 22  
Parque Tecnológico  
E - 46980 Paterna (Valencia)  
Tel. +34 (0) 96 384 37 00  
Fax +34 (0) 96 384 06 58  
E-Mail [contaval@contaval.es](mailto:contaval@contaval.es)  
[www.contaval.es](http://www.contaval.es)



**Sweden**  
elobau Nordic AB  
Träffgatan 2  
S - 13644 Handen  
Tel. +46 (0) 87 45 35 80  
Fax +46 (0) 87 45 35 82  
E-Mail [elobau@elobau.se](mailto:elobau@elobau.se)  
[www.elobau.se](http://www.elobau.se)



**Switzerland**  
BIBUS AG  
Allmendstrasse 26  
CH - 8320 Fehraltorf  
Tel. +41 (0) 4 48 77 50 11  
Fax +41 (0) 4 48 77 50 19  
E-Mail [info.bag@bibus.ch](mailto:info.bag@bibus.ch)  
[www.bibus.ch](http://www.bibus.ch)



**Turkey**  
Mr. Serdar Alper  
TR - Istanbul  
Tel. +90 212 2746111  
Fax +90 212 2747325  
E-Mail [s.alper@superonline.com](mailto:s.alper@superonline.com)



**USA**  
elobau sensor technology, Inc.  
1000 Northpoint Blvd.  
Waukegan, IL 60085  
Tel. +1 847 672 7515  
Fax +1 847 672 9645  
E-Mail [contact@elobau-st.com](mailto:contact@elobau-st.com)  
[www.elobau-st.com](http://www.elobau-st.com)

**Inlandsvertretungen Deutschland**  
**National Agencies Germany**  
**Agences Nationales Allemagne**



**Felix Aumann**  
 St. Aignan Straße 9  
 88069 Tett nang  
 Telefon +49 (0) 75 42 / 9 39 67 66  
 Fax +49 (0) 75 61 / 97 04 21  
 Mobil +49 (0) 171 / 490 61 77  
 E-Mail f.aumann@elobau.de

PLZ-Bereich  
 70000 - 71799  
 73000 - 74999  
 97860 - 97999  
 88000 - 88099  
 88180 - 88999  
 89000 - 89199  
 89500 - 89619



**Bause Messtechnik GmbH**  
 Baldurstraße 3  
 40549 Düsseldorf  
 Telefon +49 (0) 2 11 / 43 61 97-0  
 Fax +49 (0) 2 11 / 43 61 97-29  
 E-Mail info@bause.de  
 www.bause.de

PLZ-Bereich  
 32000 - 33999  
 40000 - 49999  
 50000 - 53999  
 57000 - 59999



**Michael Kappaun**  
 Freiburger Allee 50  
 04416 Markkleeberg  
 Telefon +49 (0) 3 41 / 35 01 96 10  
 Fax +49 (0) 3 41 / 35 01 98 22  
 Mobil +49 (0) 160 / 587 94 42  
 E-Mail m.kappaun@elobau.de

PLZ-Bereich  
 01000 - 19999  
 39000 - 39999  
 96500 - 96599  
 98000 - 99999



**Jürgen Kockrick-Lotze**  
 Limesstraße 17  
 63694 Limeshain  
 Telefon +49 (0) 60 47 / 98 72 95  
 Fax +49 (0) 60 47 / 98 72 82  
 Mobil +49 (0) 174 / 335 24 76  
 E-Mail j.kockrick@elobau.de

PLZ-Bereich  
 34000 - 36999  
 54000 - 56999  
 60000 - 67999  
 68550 - 68699



**Mike Mauscherning**  
 Rohrbacher Straße 27  
 78098 Triberg  
 Telefon +49 (0) 77 22 / 86 91 70  
 Fax +49 (0) 77 22 / 86 91 71  
 Mobil +49 (0) 175 / 577 82 43  
 E-Mail m.mauscherning@elobau.de

PLZ-Bereich  
 68000 - 68549  
 68700 - 68809  
 69000 - 69999  
 72000 - 72999  
 75000 - 79999



**Ralf Hollwedel**  
 Lange Straße 30  
 27211 Bassum  
 Telefon +49 (0) 42 41 / 804 78 80  
 Mobil +49 (0) 170 / 789 84 15  
 E-Mail r.hollwedel@elobau.de

PLZ-Bereich  
 20000 - 29999  
 30000 - 31999  
 37000 - 38999



**Heinz H. Otto Industrivertretungen (CDH)**  
 Südstraße 12  
 96142 Hollfeld  
 Telefon +49 (0) 92 74 / 909 91-0  
 Fax +49 (0) 92 74 / 909 91-199  
 E-Mail industrivertretungen@heinz-otto.de  
 www.heinz-otto.de

PLZ-Bereich  
 80000 - 87999  
 88100 - 88179  
 89200 - 89499  
 90000 - 96499  
 97000 - 97539  
 97600 - 97859

# Symbolerklärung

## Key to symbols

### Explication des symboles

	SIL-fähig	SIL-capable	SIL-capable
	CAN-Bus fähig auf Anfrage	connection to CAN-Bus-system on request	compatible réseau CAN selon spécification
	IP-Schutzklassifikation nach DIN EN 60529	Protection class according to DIN EN 60529	Classe de protection à la norme DIN EN 60529
	Max. Betriebsspannung	Max. operating voltage	Tension d'alimentation maxi
	Max. Schaltspannung	Max. switching voltage	Tension de commutation maxi
	Analogausgang	Analogue output	Sortie analogique
	Digitalausgang	Digital output	Sortie digitale
	Winkelbereich	Angle range	Plage de mesure
	beleuchtet	illuminated	illuminée



## elobau goes green.

**e** **no CO<sub>2</sub>** Einen großen Schritt in Richtung „Green Production“ haben wir mit dem Erwerb eines Solarkraftwerkes geleistet. Seit 2010 sind wir zertifiziert nach DIN 14001:2009. Mit weiteren Maßnahmen, wie die Beheizung über Biogas oder den Bezug von ausschließlich Grünstrom, haben wir es erreicht, dass unser Unternehmen klimaneutral arbeitet. Wir können stolz darauf verweisen, dass alle elobau Produkte CO<sub>2</sub>-neutral hergestellt werden. Hierzu wird periodisch eine Energiebilanz erstellt und ein entsprechender Ausgleich gewährleistet.

Warum betreiben wir diesen Aufwand und sind nicht nur rein auf ökonomische Ziele ausgerichtet? Die Antwort ist einfach aber weittragend: „Wir sind überzeugt, dass dies ein wesentlicher Faktor ist, um auf Dauer erfolgreich zu sein. Denn nur Unternehmen, die in der Gesellschaft voll anerkannt sind, werden zukünftig in der Lage sein, gute Mitarbeiter zu rekrutieren und auf Dauer zu halten.“

With the acquisition of a solar power plant, we have taken a big step towards “green production”. We have been certified in accordance with DIN 14001:2009 since 2010.

Through additional measures, such as heating with biogas and using only green power, our company now operates in a carbon-neutral manner. We are proud to say that all elobau product manufacture is CO<sub>2</sub>-neutral. Energy usage is reviewed regularly and compensation is made for any offset.

Why do we make this effort instead of focusing purely on economic goals? The answer is simple but far-reaching: “We are convinced that this is a key factor for long term success. Only companies that are fully respected in society will be in a position to recruit good employees in the future and also keep them in the long run.”

En achetant une centrale hélioélectrique, nous avons fait un grand pas en direction de la « production verte ». Nous sommes certifiés DIN 14001:2009 depuis 2010.

Grâce à des mesures supplémentaires telles que le chauffage au biogaz et l'utilisation exclusive d'énergie renouvelable, nous avons réussi à faire en sorte que notre entreprise travaille en faveur de la neutralité climatique. Nous pouvons être fiers de dire que la production des produits elobau est entièrement réalisée sans CO<sub>2</sub>, une performance qui fait l'objet de bilans énergétiques réguliers et de compensations correspondantes.

Pourquoi tous ces efforts et non la poursuite d'objectifs purement économiques ? La réponse est simple mais de grande portée : « Nous sommes convaincus qu'il s'agit ici d'un facteur essentiel du succès durable. En effet, seules les entreprises pleinement reconnues au sein de la société seront à l'avenir en mesure de recruter de bons collaborateurs et de les faire rester. »

[www.elobaugoesgreen.de](http://www.elobaugoesgreen.de)



Selbstverständlich wurde auch dieser Katalog nachhaltig und umweltfreundlich produziert.  
This catalog was, of course, also produced in a sustainable and environmentally friendly manner.  
Il va de soi que ce catalogue a lui aussi été produit dans une perspective de durabilité et de protection environnementale.



**elobau** 

GmbH & Co. KG  
Zeppelinstr. 44  
88299 Leutkirch  
Germany

☎ +49 (0) 75 61 97 00  
☎ +49 (0) 75 61 97 01 00  
[www.elobau.com](http://www.elobau.com)  
[info@elobau.de](mailto:info@elobau.de)